

14th ANNIVERSARY NUMBER

RADIO WORLD

REG. U.S. PAT. OFF.

*COVD
COLOR*

CODE

THE HOW-TO-MAKE-IT MONTHLY

25c Per Copy

NEW FACTS ON SHIELDING

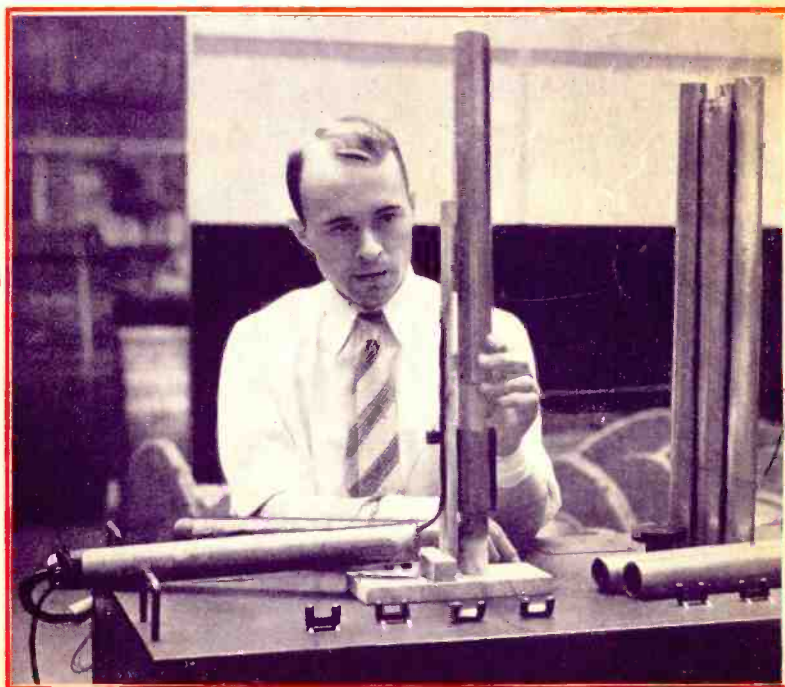

*CON
CODE*

6B3

6L7

Interference caused by inductive leakage from any transmission line can be checked by proper shielding. A new insight into shielding is provided by considering impedance of a radial line. See page 47.

APRIL

BLUEPRINT OF 5 TUBE T.R.F. SET

1936

They May Look Alike

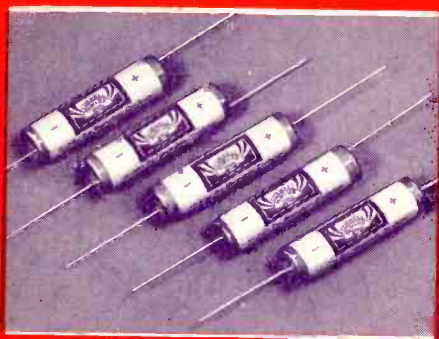

BUT...

*There's a
World of
Difference*

in C-D ELECTROLYTICS

**From the outside, all electrolytics look more or less alike.
Open a C-D electrolytic and you note the difference.**

Here on the inside . . . you behold the secret why C-D electrolytics are the world's most accepted line of condensers.

Before any unit leaves the factory, it is subjected to laboratory tests which accurately measure its ability to render service under the most severe conditions. Maximum life—minimum leakage—constant capacity characteristics—non-corrosive construction—are all assured by careful control of the factors of design, the production methods, and the selection of raw materials.

No other make of electrolytic condensers has the exceptionally fine electrical characteristics and the dependability of the Cornell-Dubilier High Formation Electrolytics!

Write for free catalog today. The latest types of ELECTROLYTICS, PAPER, MICA, AND DYKANOL condensers are illustrated in detail.

CORNELL-DUBILIER
C O R P O R A T I O N

4343 BRONX BOULEVARD • NEW YORK

POLICE CALLS
PRIVATEUR CALLS
AIRPLANES

SCOUT

JUNIOR ALL
ONLY KIT OF ITS KIND IN THE WORLD

WAVE

SHIP-TO SHORE
10%550 METERS
CODE

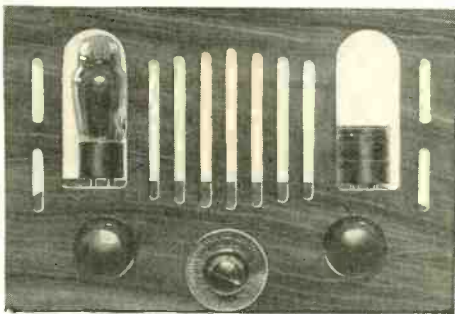

AIR

2

2

ALL

COMPLETE WITH ALL
PARTS - TUBE
AND 2 COILS COVERING
BAND 70%550 METERS

AT LAST! AN ALL WAVE KIT INCLUDING TUBE ^F ONLY \$2.

THRILLING SHORT WAVE ^A BROADCAST ENTERTAINMENT
A REAL ALL WAVE RADIO - NOT A TOY

USES 2 FLASHLIGHT
CELLS AND SMALL
22KV "B" BATTERY
SHIPPING WT--1 LB

FOREIGN ¹⁵⁻⁸⁰ METERS RECEPTION

STANDARD BROADCAST RECEPTION

COMPLETE ² KIT CONSISTS OF THESE PARTS

- 1 WOOD PANEL, WALNUT FINISH
- 1 BLACK ² GOLD FINISH CALIBRATED DIAL
- 1 VARIABLE TUNING CONDENSER
- 1 REGENERATION CONTROL-POTENTIOMETER
- 1 FILAMENT RHEOSTAT
- 1 GRID LEAK RESISTOR
- 1 MICA GRID CONDENSER
- 1 ROLL ² HOOK UP WIRE
- 1 ANTENNA TRIMMER CONDENSER
- 1 MICA BY-PASS CONDENSER
- 1 ANTENNA CONNECTION CLIP
- 1 "A" PLUS-GROUND CONNECTION CLIP
- 1 "A" MINUS-"B" MINUS CONNECTION CLIP
- 1 "B" PLUS CONNECTION CLIP
- 2 EARPHONE CONNECTION CLIPS
- 1 COIL COVERING BROADCAST BAND %550 METERS
- 1 COIL COVERING SHORT WAVE BAND -
70-200 METERS
- 3 KNOBS
- 1 TUBE SOCKET 1 COIL SOCKET
- PICTURE WIRING DIAGRAM-DETAILED INSTRUCTIONS
- ... 1-30 TYPE TUBE ...

AUXILIARY PARTS SOLD ONLY WITH KIT

SINGLE EARPHONE	-----	\$ 65
DOUBLE EARPHONES	-----	1 40
COMPLETE ANTENNA KIT	-----	.50
2 "A" BATTERIES (FLASHLIGHT)	EA.	.10
22 1/2 VOLT "B" BATTERY	-----	.75
10-20 METER COIL	-----	.25
15-45 METER COIL FOR FOREIGN	-----	.25
40-80 METER COIL) RECEPTION	-----	.25
WOOD SCREW KIT	-----	.10
WOOD CHASSIS KIT	-----	.45

ENCLOSE ² 1 DEPOSIT WITH C.O.D. ORDERS
NO CIRCULARS AVAILABLE ♦ ORDERS FILLED ² ROTATION
CLIP COUPON

Gentlemen:-
Enclosed find 2 for complete
Air Scout Junior All Wave Kit
Name: _____
Address: _____

H.G. CISIN, CHIEF ENG. ALLIED ENGINEERING INSTITUTE -
DEPT. RW5 98 PARK PL. NEW YORK, N.Y.

HAYNES R-S-R RECEIVER

2 1/2-555 METERS

Regeneration plus Super Regeneration

Combined for the first time in a single receiver with the greatest tuning range ever incorporated in any radio set.

WRITE FOR FREE CIRCULAR

Price of Complete HAYNES K.S.R. RECEIVER—wired and tested in our laboratory—with black crystalline hinged top cabinet, and 5 tubes (2 MG 43's, 1 MG 43, 1 MG 25Z5, 1 76, ready to plug in) **\$24.65** and operate

Complete Kit including wired switch band Coil Assembly, drilled panel and chassis, dynamic speaker, wiring diagram instructions..... **\$14.95**

Black crystalline cabinet.... **\$2.50**

Five tubes (2 MG 6K7's, 1 MG 43, 1 MG 25Z5, 1 76.... **\$3.60**

- ★ Dual regeneration control with hiss reduction control on super-regeneration.
- ★ Adjustable selectivity control.
- ★ Both loud speaker and earphone reception on all bands.



- ★ 2 1/2-555 meters—complete coverage of this tremendous tuning range with no skips or dead spots.
- ★ Band switching (5 bands)—no plug in coils from 15-555 meters.
- ★ Immediate shift from regeneration to super-regeneration is accomplished by merely turning switch knob under speaker.
- ★ Super-regeneration below 15 meters using simple efficient pin-jack plug in coils.

RADIO CONSTRUCTORS LABORATORIES

RACO
PRODUCTS

136 LIBERTY ST.
NEW YORK
DEPT. RWLH



G R E A T E S T

Book Ever Printed
for Radio Amateurs
and Experimenters
1936 EDITION

of 'THE RADIO Handbook'

★ **ALMOST 400 PAGES**
ONLY \$1.00 PER COPY

▲ Many radio books are published, some you'd like to have, others you ought to have, and just a few others you **MUST** have. Here is one of the **MUST** list—"The Radio Handbook," with transmitter and receiver circuits galore, a wealth of fundamental radio information for amateur and experimenter, and what's more, everything authoritative. Imagine! Almost 400 pages, and only \$1, *postpaid*. Send that dollar now, get the book quickly, and study it slowly, when finished you'll know amateur radio and experimenting, if you don't now. And if you do now, you'll think you didn't after you have.

Send Check, M. O. or Currency to:

RADIO WORLD

145 WEST 45th STREET, NEW YORK CITY

R-F COIL WINDING MADE EASY

ALL you need are any standard wire and coil form and you can wind a radio-frequency solenoid to any requirement from information contained in "The Inductance Authority." No calculation is needed. Quick consultation of simple charts gives the answer in number of turns and gives it with high accuracy. This is the indispensable book for those who wind their own coils.

Sent prepaid anywhere on earth on receipt of \$2.00. Or send \$5.00 for a two-year sub. for Radio World and this valuable book will be sent free as a premium.

RADIO WORLD

145 W. 45th STREET NEW YORK CITY

RADIO ENGINEERING

RCA Institutes offers an intensive course of high standard embracing all phases of Radio. Practical training with modern equipment at New York and Chicago schools. Also specialized courses and Home Study Courses under "No obligation" plan.



Illustrated Catalog on request Dept.
RCA INSTITUTES, Inc. WR-36
75 VARICK STREET, NEW YORK, N. Y.
1154 MERCHANDISE MART, CHICAGO

Recognized Standard in Radio Instruction Since 1909

RADIO WORLD

The How-to-Make-It Monthly—Fourteenth Year

ROLAND BURKE HENNESSY
Editor

HERMAN BERNARD
Managing Editor

HERBERT E. HAYDEN
Advertising Manager

Table of Contents for APRIL, 1936

Finding the Direction of Motion of An Oscilloscope Spot 6	Scouting Foreign Stations 30
<i>How Slowness of Eye Is Overcome</i> By J. R. Haynes	<i>Can Be Done With One Tube Set</i> By H. G. Cisin
Two Band A.C. Tuner 8	The Favorite Receiver 32
<i>Circuit, Seldom Encountered, Feeds Any Amplifier</i> By Madison C. Fargo	<i>Five Tube A.C. Tuned R.F. Set</i> By Jack Goldstein
Amplitude and Frequency Modulation 10	New Tuning Indicator Tube 38
<i>How They Differ and Don't</i> By M. N. Beitman	<i>6G5 Cutoff Is at Minus 22 Volts</i> By W. M. Perkins
Fundamental Principles of Radio 12	Testing Vacuum Tubes 42
<i>Direct and Alternating Current Analyzed</i> By F. T. Holmquist	<i>Methods Analyzed and Frankly Compared</i> By Vincent R. Meehan
Coils and Their Primaries 18	The 6L7 as an Amplifier 46
<i>High Gain Compared to Selectivity</i> By Francis X. Hargy	<i>Sharp Cutoff Without Cross-modulation</i> By Cap. Peter V. O'Rourke
Layout and Wiring Importance . . . 21	A New Shielding Theory 47
<i>Advice Illustrated by Neat Example</i> By Stephen Masters	<i>Impedance Effects of Radial Line as Basis of Real Values</i> By Sergei A. Schelkunoff
An Audio Beat Oscillator 24	Service Bureau 51
<i>Two Heater Triodes in Hartley Rig</i> By Louis Kranz	<i>Identities of Metal Tube Pins</i> <i>Bottom Views Metal Tubes</i> <i>Tabulated Characteristics of Metal Tubes</i>
I.F. Channel Without Coils 26	Radio Construction University . . 54
<i>Used in Five Meter Superheterodyne</i> By Frank Lester	<i>Answers to Questions on the Building and Servicing of Radio and Allied Devices</i>
Unique for Measurements 28	News of Television 57
<i>Rig Checks Equal, Higher or Lower Frequencies</i> By Herman Bernard	

Vol. XXIX, April, 1936. No. 1. Whole No. 691. RADIO WORLD, published monthly by Hennessy Radio Publications Corporation, 145 West 45th Street, New York, N. Y. Editorial and executive offices, 145 West 45th Street, New York, N. Y. Executives of RADIO WORLD: Roland Burke Hennessy, editor and business manager; Herman Bernard, managing editor; Herbert E. Hayden, advertising manager. Officers of corporation: Roland Burke Hennessy, president-treasurer; Roland Burke Hennessy, Jr., vice-president; Herman Bernard, secretary. Entered as second-class matter March, 1922, at the Post Office at New York, N. Y., under Act of March 3d, 1879.

SUBSCRIPTION RATE

Price 25 cents per copy. Subscription \$2.50 per year (12 issues), postpaid in United States and Possessions; \$3.00 per year postpaid in all other countries. Remittance for foreign subscription should be by International money-order (postal or express) or draft against or discountable at New York bank.

RADIO WORLD is distributed by the American News Company and its Branches

Finding Motion Direction of Oscilloscope Spot

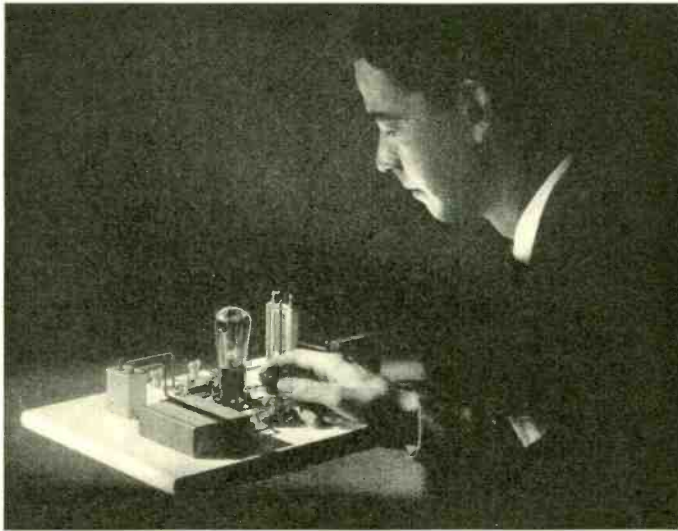

By **J. R. Haynes**

Physical Research, Bell Telephone Laboratories, Inc.

THE moving spot of light which generates the characteristic fluorescent patterns in a cathode ray oscilloscope is usually vibrating so rapidly that it is impossible for the eye to detect its instantaneous direction of motion.

It is sometimes important, however, in experimental work that this direction be definitely known. This was the case recently in a study of mechanical hysteresis in microphone trans-

mitters and on account of the special conditions which had to be met it was found necessary to devise a new method for determining such directions of motion.

A simple gas tube relaxation oscillator like that shown diagrammatically in Fig. 1 was constructed.

Principle of Operation

This operates by gradually building up a potential difference across the condenser C until the critical breakdown voltage of the tube is reached at which time the condenser discharges. By properly choosing the values of R and C the condenser can be made to charge and discharge

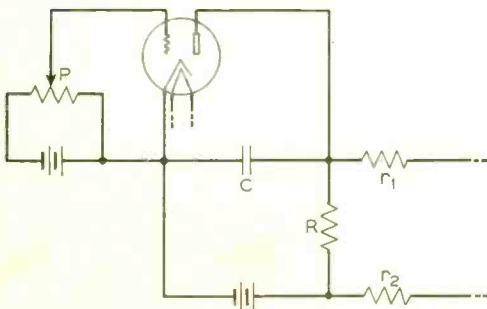

FIG. 1

A gas tube relaxation oscillator, shown here diagrammatically, is used to provide a rapid succession of timed impulses.

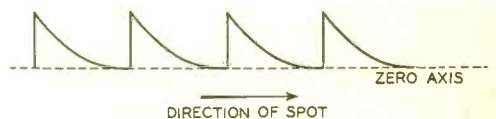

FIG. 2

A saw-tooth wave-form is obtained when the output of the oscillator is connected to a cathode ray oscilloscope with a time sweep axis. The serrations point in the direction of motion of the oscilloscope spot.

Microphone Research Specialist

J. R. HAYNES has been engaged in fundamental research relating to microphonic action since he joined Bell Telephone Laboratories in 1930. In these studies the cathode ray oscilloscope has proven an important aid for the analysis of complex cyclic currents. The determination of the direction of motion of the cathode ray spot has also been found necessary in these investigations and Mr. Haynes devised for this purpose the simple means described in the accompanying article. He received the degree of B.S. in Physics at the University of Kentucky in 1930.

at rates varying from one to 20,000 times per second.

If the output of such an oscillator is connected to one axis of a cathode ray oscilloscope and the other axis is made a time sweep circuit a saw-toothed wave like that shown in Fig. 2 results. The saw teeth which are caused by the sudden increase of voltage across R when the condenser C discharges and the subsequent slow decrease as it charges again may be thought of as arrows pointing in the direction of motion of the spot.

700 to 8,000 Cycle Range

Thus if it is desired to measure the direction of motion of the cathode ray spot in any

cathode ray oscilloscope figure it is necessary only to connect the relaxation oscillator, tuned to the appropriate frequency, through suitable high resistance leads r_1 and r_2 , Fig. 1, and superpose the saw tooth wave on the figure in question. It has been found that a Western Electric 256A vacuum tube used with a capacity of .0005 mfd. and a resistance of one megohm will cover the desired frequency range of from 700 to 8,000 cycles per second.

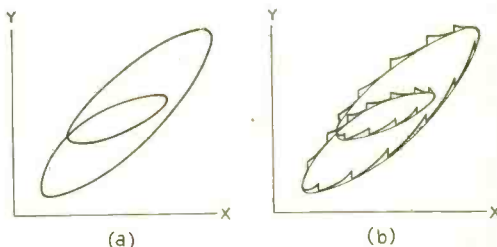

FIG. 3

The oscilloscope pattern (a) is changed to that shown at (b) when the relaxation oscillator is applied, thus indicating in this case that the oscilloscope spot is actually rotating in a clockwise direction.

The appearance of an oscilloscope pattern without and with the relaxation oscillator is illustrated in Fig. 3a and 3b, respectively. The direction of motion of the spot in this particular case was clockwise.

Because of its simplicity and adaptability it is felt that this method of determining the direction of motion of a cathode ray oscilloscope spot may be applicable to a wide variety of circuits.

Power Ratings of the 6B5

Power output and distortion were measured over a wide range of load resistance, plate volts 300, grid volts 0, in testing the 6B5. An optimum load of 7,000 ohms can easily be chosen for at this point the total harmonic content is lowest and the power output is approximately maximum. A comparison of this power output curve with a power output curve of a pentode reveals an advantage in the new tube in that the power output versus load resistance is essentially flat. Most speakers are quite inductive and consequently their impedance varies with frequency. A flat load characteristic such as this eliminates the accentuation of "highs" that is noticeable with pentodes. Also the distortion as measured under ideal conditions is the same as actually encountered when an inductive load such as a speaker is used.

For $E_b = 250, 300$ and 325 volts an output of 2.5, 4.0 and 5.5 watts, respectively, can be obtained. The distortion at these levels is 5% total. As the plate current does not vary with signal, a power supply suitable for Class A operation will be satisfactory for these tubes.

For running push pull curves a signal of 35 volts rms was used and a supply voltage of 300.

A load of 10,000 ohms plate to plate is easily selected as optimum, since power output at this point is essentially maximum with a low harmonic content. The power output vs load resistance curve is again flat. The distortion level is very low and being practically all third harmonic, the third harmonic is plotted as total harmonic. For the push pull connection with supply voltages of 250, 300 and 325 volts, the outputs for 5% total harmonic distortion with these supply voltages are 8.0, 12.0 and 13.0 watts, respectively.

For a 400 volt use of the 6B5 some means must be provided to restrict the plate current. The plate current at no signal is held down to 40 ma for I_{p2} and 4.5 ma for I_{p1} . The plate dissipation with no signal is only 16 watts, which is no greater than the plate dissipation at 325 volts. The optimum load is again 10,000 ohms and the total harmonic distortion is 5% at 20 watts output. A fixed bias of from eight dry cells (normally 8×1.58 or 12.64 volts). A bias resistor of 140 ohms, the plate of the input triode alone may be connected to 280 volts. If the 140 ohm cathode resistor is used it must be by-passed to eliminate distortion. A 25 mfd. condenser is sufficient.

Rather a Rarity

A Two Band Tuner for A.C. Use

By Madison C. Fargo

OUTPUT MAY BE FED TO ANY AMPLIFIER

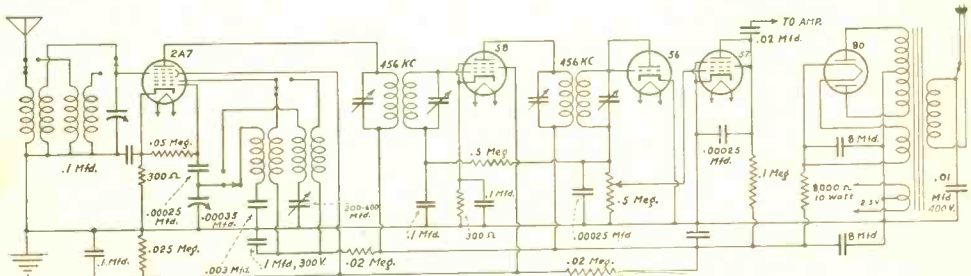

You don't often see a circuit diagram of a two band superheterodyne tuner, but here it is.

YOU seldom see the diagram of a two band superheterodyne tuner. The object of such a tuner is to feed a power amplifier with radio program reception. Only five tubes are used, there is one intermediate frequency stage, and the output is taken from an audio amplifier tube.

The two bands are (1) standard broadcast and (2) foreign short wave broadcast. Separate coils are used at the station frequency and oscillator levels, not tapped coils.

Since there is no power tube in this set, not much B current is drawn, and a transformer intended for a four tube set may be used, although there are five tubes. Also, a resistor may be

used in place of a choke coil, since the current is low, and indeed resistor should be used, as the B voltage otherwise would be considerably higher than needed.

The station carrier frequency is selected by the first tuned circuit, upper left, and with this frequency is mixed the oscillator frequency, lower left, to produce the intermediate frequency that appears across the primary of the first i.f. transformer, the one between the 2A7 and the 5B.

This tube, the 58, is the intermediate amplifier, and may produce a gain of around 100. The 56 is circuited as a diode only, and its output com-

LIST OF PARTS

Coils

One antenna coil and one oscillator coil for standard broadcast band; one antenna coil and one oscillator coil for foreign short wave band.

One power transformer for four tube set. Primary, 115 v. 50-60 cycles; secondaries, 300-0-300; 5 volts; and 2.5 volts center tapped.

Condensers

One two gang .00035 mfd. tuning.
 One 200-600 mmfd. padding, compression type.
 Two .00025 mfd. mica fixed.
 One .003 mfd. mica fixed.
 One .02 mfd. mica fixed.
 One .01 mfd. 400 volt tubular.
 Six .1 mfd. 300 volt tubular.

Two 8 mfd. Cornell-Dubilier electrolytics, 450 continuous d.c. voltage rating, in one cylindrical container.

Resistors

Two 300 ohm
 One 25,000 ohm
 One 8,000 ohm
 One .1 meg.
 One .5 meg. pot.
 (Resistors 1 watt rating unless otherwise stated)

Two 20,000 ohm
 One 50,000 ohm
 10 watt rating
 One .5 meg. fixed.

Other Requirements

Chassis Tubes Dial. Three knobs.
 Three grid clips. Ant.-Gnd. Posts.
 Output post.

municated to the first audio amplifier, a 57 with screen and plate connected together externally. Volume is controlled by taking off as much or as little as desired of the rectified signal voltage. The 57 thus used is a high mu quadrode, considering the presence of the suppressor.

Such a circuit should not be worked with a long aerial, in fact, since selectivity ahead of the mixer should be as great as practical for such a modest circuit, the easiest way to attain practical selectivity is to use no more aerial than 20 feet of wire indoors.

One way to make the adjustment is to check whether turning the volume control all the way up introduces distortion accompanied by reduction of volume toward the end of the rotation. If such actually takes place, then the aerial should be shorter, but never more than 20 feet, except in "truly rural" locations. Too long an aerial makes tracking difficult under any

circumstances, due to the extra capacity and pickup. If, however, one has neither the meter nor the signal generator, and is to rely on a station, turn to the short wave band, pick up a weak station but of steady volume (no fading) and adjust the i.f. coils for maximum response, which may be done aurally. Then adjust the broadcast band for maximum sensitivity by adjusting the series padding condenser for maximum response at 600 kc or thereabouts, the required capacity being around 300 mmfd. Since for the foreign band the frequencies will be about ten times as high, the padding condenser will be about ten times as great, .003 instead of .0003 mfd., so being very large compared to the tuning condenser itself, may be a fixed value.

The output lead, from the 57 tube, must not be run near the a.c. line cord, otherwise hum is strong. Properly safeguarded against such pickup, the output is free of hum to under 1%.

It is advisable to have the intermediate frequency coils sharply tuned, and this is most readily done with a signal generator and output meter. Use the generator at modulated position. If you have a sensitive d.c. meter (.2 ma or better) the adjustment may be made without modulation from the signal generator, for maximum deflection when meter is in series with the potentiometer, say, between one end of the potentiometer and ground. A signal of some intensity may be used and this method works well. Even a station local serves a satisfactory purpose.

Not much to the wiring, no difficulty in tuning, for everything is easy about this two band tuner.

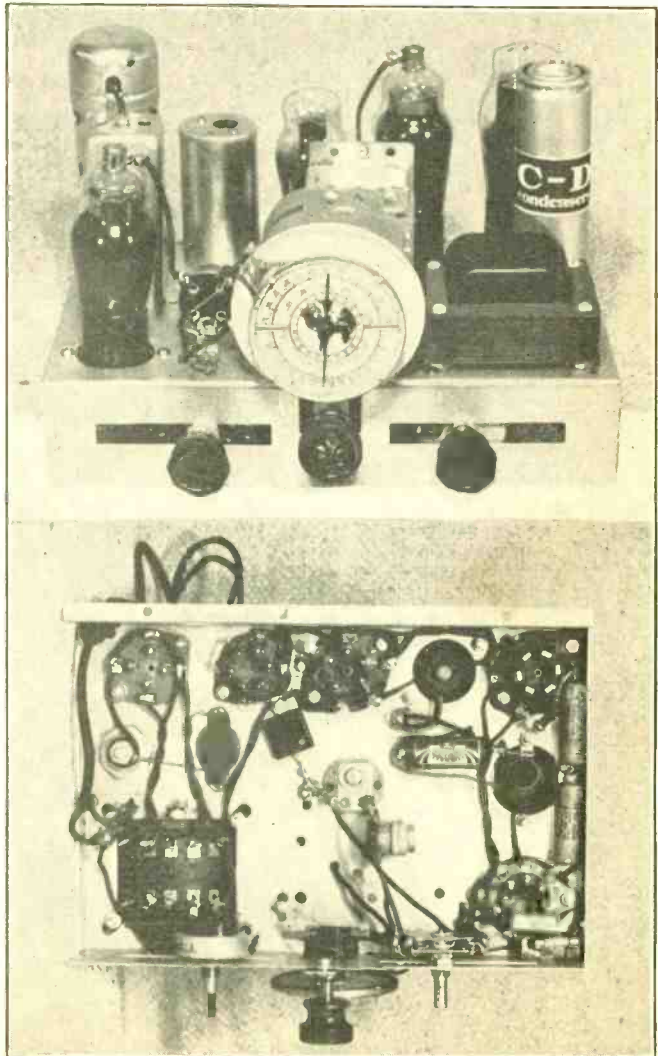

Amplitude and Frequency Modulation

By **M. N. Beitman**

Engineer, Allied Radio Corp.

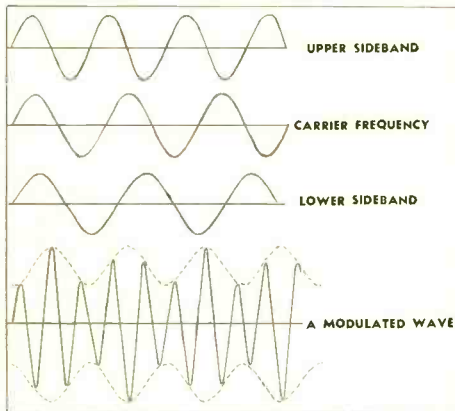

FIG. 1

The upper sideband is mathematically equivalent to a higher frequency than the carrier, the lower sideband equivalent to a lower frequency. The modulated wave is modulated less than 100%.

THE transmission of radio telephony is directly related to the process of modulation. A modulated radio frequency wave has either its amplitude or frequency, or both, varied in accordance with the audio signal.

While at the present time amplitude modulation is almost universally employed, certain definite advantages of frequency modulation and recent developments in the communication engineering field along this line point to the fact that frequency modulation will soon be used to a greater extent and perhaps supersede the present amplitude method of modulation.

Therefore while at present the best adaptable methods of modulation are debatable and are in a transient stage, it is interesting to consider the advantages and analyze the two methods of modulation.

Variation of Antenna Current

When not modulated, an antenna current of a well made transmitter varies sinusoidally and is of a single frequency, commonly termed the carrier radio frequency.

The process of amplitude modulation involves the combination of the carrier radio frequency and the modulating audio frequency to produce two additional frequencies co-existent in all the stages of the transmitter following the stage where modulation took place.

These two new frequencies are the sideband frequencies. The carrier frequency plus the

modulating frequency forms the upper sideband, and the carrier minus the modulating frequency forms the lower sideband.

In the case where each broadcasting station is assigned a channel 10 kc. wide, each sideband may be only 5 kc. (5,000 cycles) wide. This fact limits the upper limit of the transmitted audio signal to 5,000 cycles. The speech and music transmitted is a series of complex waves of a wide frequency range, at present limited by narrow channels and transmitting apparatus design to a band approximately from 40 to 5,000 cycles.

Relationship Depicted

The relation between the carrier and the sidebands may be represented graphically in three different ways. The wave forms of the carrier and each of the sidebands may be plotted against the same time scale either individually in three curves or combined. See Fig. 1.

In Fig. 2 the carrier and the sideband voltage amplitudes are represented by a vector diagram. The phase relations will vary with the modulating frequency, the maximum and minimum amplitudes occurring respectively when the sideband vectors are in phase or exactly out of phase with the carrier vector.

It is evident, of course, that the sideband vectors vary in amplitude equally at all times and rotate at equal amounts but in opposite directions.

Another graphical view point is given in Fig. 3, where the voltage amplitudes of the carrier and the sidebands are plotted against their instantaneous frequencies.

Motion in Unison

As the frequency of the audio modulating signal changes, the two sidebands will move in unison to and from the carrier.

Since transmission of audio frequencies is accomplished by changes in the antenna current's amplitude, it is of definite advantage to modulate the carrier frequency 100%, i.e. between twice the average value and zero, when transmitting the loudest signals. Of course, even in a 100% modulated transmitter the *average* signal will cause much less than 100% modulation.

On peaks, in a 100% modulated transmitter, the sidebands will represent but one-third of the total radiating power. The average power represented by the sidebands will be considerably less.

Suppression Practiced

The carrier frequency does not transmit any signal, but merely acts as a reservoir of energy

for the sidebands. Therefore it is possible entirely to remove the carrier after this task has been accomplished. By incorporating in the receiver an oscillator operating at the carrier frequency and having intensity set relative to the incoming sidebands, beating this oscillator's frequency against the received sidebands makes it possible to reconstruct the original signal.

Further, since either sideband carries all the characteristics of the audio signal, the other sideband producing no greater intelligence but more power, it is possible to suppress either sideband.

This suppression or elimination of either the upper or lower sideband is easily accomplished by means of suitable wave filters. In many

to a condenser microphone) connected in parallel with the LC circuit of the oscillator. Audio frequency vibrations of the air set up by the signal would cause a movement of the plates of the "microphone" condenser and in turn alter the LC constant, thereby changing the oscillator frequency.

Elaborate mathematical analysis of frequency modulation has definitely pointed out that the resultant wave consists of distinctive sidebands of constant frequency. These sidebands are evenly spaced by multiples of the audio frequency signal on both sides of the frequency obtainable from the oscillator when no audio excitation takes place. These sidebands diminish greatly in intensity as they recede from the

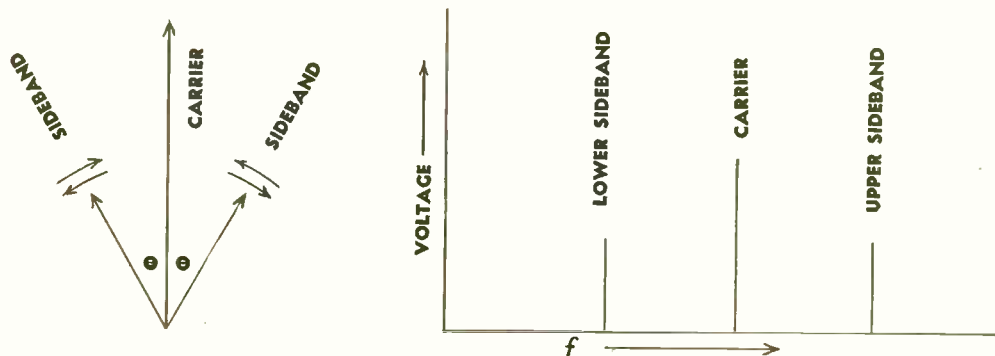

Two methods of representing the relationship between the carrier and the sidebands. At left the vector method is used. The sideband vectors rotate in opposite direction with respect to the rotation of the carrier. At right the same relation is shown on a frequency scale.

high power, long distance transmitters either one sideband or the carrier (or even both) are suppressed with considerable reduction of power consumption and greatly narrowing the used frequency band.

Constant Amplitude

Audio amplification takes place in a suitable amplifier called the modulator which is coupled to some radio frequency amplifier tube of the transmitter. Either plate or grid modulation is employed, although somewhat more novel schemes are occasionally used with multi-element tubes.

In a frequency modulated transmitter modulation occurs in the oscillator, eliminating the need for the modulating amplifier. Besides this outstanding advantage, frequency modulation does not vary the amplitude of the antenna current and therefore permits the use of high efficiency class C amplifiers in all stages. The constant amplitude also greatly reduces cross talk interference.

To obtain frequency modulation it is only necessary to vary, in accord with the signal, either the inductance or capacity of the oscillator tuned circuit.

Way to Frequency Modulate

One such method would be the use of a small capacity, large size condenser (similar

average oscillator frequency. It is evident that to transmit audio signals up to 5,000 cycles per second, possible with amplitude modulated transmitters occupying 10 kc. channels, with frequency modulated transmitters much wider channels would be required if interference is to be avoided. This difference between the two methods of modulation is the prime reason for the present day use of amplitude modulation instead of frequency modulation.

BROADCAST INDUCTANCES

WHAT is a very suitable secondary inductance for r.f. tuning with .00035 mfd., also what are oscillator inductances and series padding capacities for 515, 465, 456 and 175 kc (broadcast band)?—Answers below:

- R.f. inductance 253 microhenries
- 515 kc oscillator, 136.5 microhenries (Cp = 300-350 mmfd.)
- 465 kc oscillator, 113.5 microhenries (Cp = 350-450 mmfd.)
- 456 kc oscillator, 115.8 microhenries (Cp = 350-450 mmfd.)
- 175 kc oscillator, 202.0 microhenries (Cp = 800-1300 mmfd.)

Fundamental Principles of Electrical Action Comprising Radio

By F. T. Holmquist

MANY persons have an interest in radio beyond listening to programs, an interest based on a mechanical or electrical bent, and would like to establish some groundwork for an insight into the performance and even construction of sets, possibly even with the idea of profiting financially later on from the knowledge that will come in the course of further study. For the benefit of such persons therefore some fundamentals will be set forth, with the idea of presenting bare necessities of comprehension. Even those versed in radio sometimes ascertain a fact hitherto unknown to them, in perusing data presented essentially for beginners.

Radio includes a vast amount of technical information and learning, probably too vast for any one person's life, and as a result men and women specialize in particular branches of radio science, but all must begin with a knowledge of fundamentals, and some of the simplest of them lead to the most important inventions and other innovations of radio practice.

The Electron Theory

What is most important is a matter of opinion, and the varied treatment in comprehensive textbooks attests to this. But it seems

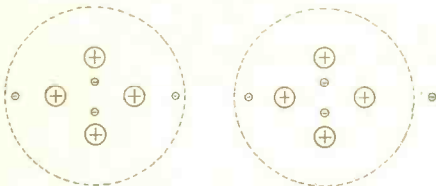

The dashed circle represents in each instance an atom. At left, four positively charged particles of electricity, called positrons, about center, with two negatively charged smaller particles about center and two more to left and right. The small ones are electrons. From right circle one electron has been knocked off, the atom is positively charged, hence the unmolested atom at left is negatively charged compared to the other.

to be agreed that something should be known about the electron theory, for that is the modern view of processes involved in the action of electricity, and really gives a fresh outlook upon nature and the universe.

It was formerly thought that electricity was a fluid, meaning something that flows, hence we still speak of electricity "flowing," and use other terms inherited from previous poor under-

standing of electricity, so part of what one learns consists of what one has to unlearn.

When an electromotive force, or driving influence of electricity, is applied at the terminals of a resistance or conductor, there is set up a resultant difference of potential between the terminals, equal to the potential of the source, if the source has no resistance. This potential is measured in volts.

Movement of Electrons

Since there is a potential or driving difference across a resistance there must be a driven agency, or a current flowing through that resistance. We say that the current "flows," but there is no knowledge of what electricity is, but rather of what are its effects, and it is now believed that the effect of introducing the potential is to disturb the smallest particles of electricity of which the resistor consists. These particles are called electrons, they are real, not imaginary, and they have a definite motion of their own even when undisturbed by externally applied electric influence.

It is difficult to conceive of motion we can not confirm by simple home or shop experiment, but scientists agree that the electron is a moving unit, indeed that its path is orbital, like that of the planets, so that the atoms of matter are really universes of their own, so to speak. It is not a far cry therefore to assume, as the modern trend in science indicates, that all matter is electrical, and that there is nothing in life or universe except electricity and spirit. Electricity accounts for the material and physical things, spirit for faith and religion.

What the Current Is

So when we apply potential across the terminals we disturb the electrons in their orbits, and we tend to drive them along, one might say, against their will. They would be so driven at a tremendous rate were it not for the opposition that some driven electrons encounter when they meet other electrons that are in the way. The progressing ones are bounced back a lot. As a result there is a net drift of electrons, representing the effect of subtracting the resistive force from the forward or conductive force. This net drift of electrons is what we mean when we refer to the current.

If the electromotive force is direct current, meaning that it flows in one direction only, not only does the current flow through the wire practically uniformly, but there is a field of force set up immediately about the wire. This is due to electromagnetism, which is the manifestation outside any wire through which any

form of current flows, including direct current.

The horseshoe magnet or bar magnet is familiar to many. This has an attraction for iron. The magnet has two poles, called north and south, and the attraction is solely between units of opposite polarity. Thus, a positively charged magnet pole will attract an iron piece or filing that is negatively charged, and a vice versa. The positively charged pole may be called the north pole, the negatively charged pole is the south pole of the magnet.

Permanent and Impermanent Magnets

The attraction takes place due to "mating" of electrons, and the magnetism, or attracting force, is called permanent, because the magnetism remains there, whereas with an electromagnet current flow produces the magnetism, and when the current is stopped the field, as the lines of force or phenomenal activity are called, collapses. This field has similar attracting properties to those of the permanent magnet.

In radio the permanent magnet is used to some extent, especially in magnetic speakers, whereas electromagnetism is widely used, and the radio process could not be accomplished without it.

The permanent magnet is permanently charged, the electromagnet is temporarily charged. Hence electromagnetism is used greatly in alternating current practice, which includes the radio transmitter, the carrier wave, the amplification at radio and audio frequencies, including the functioning of the reproducer.

The Time Element

So we have electromagnetism whenever we pass current through a wire. Considering direct current, which will be remembered as current flowing in one direction only, we may put a meter in series with the circuit, so we have meter, source of potential and resistor connected together one after the other, and we note the deflection on the meter. Say it reads 20 milliamperes. That means that for any given unit of time the current is 20 milliamperes. To say just "20 milliamperes" without considering time is meaningless, as the measurement is of a rate, hence based on a time. The unit of time is not often expressed, being understood, although precise textbooks would refer to 20 milliamperes t, giving significance to the importance of considering time, represented by the initial t.

The voltage is simply understood as the potential difference, whether or not current otherwise flows, and is measured by putting the meter across the circuit, that is, in parallel with it, not in series.

Subdivisions of Units

Since current represents rate of flow, if power is related to current, then it is related to time. Power is the product of the voltage in volts and the current in amperes, for direct current values, and expresses the time rate of energy. Whenever work is done in an electrical circuit it is accomplished through energy, and although voltage in non-pulsating direct current

practice is independent of time, the current element brings in the time consideration. Power is expressed in watts, just as potential is expressed in volts and current in amperes. The subdivisions are millivolts and microvolts, milli-amperes and microamperes, milliwatts and microwatts, for thousandths and millionths of the units.

So if one ampere is flowing in a circuit across which there is a potential difference of one volt there is a power consumption of one watt. When there is some particular reason for not leaving the time element to be "understood," as when power companies send in their bills monthly, the rating is in kilowatts, meaning thousands of watts, and hours, shortened to kilowatt hours. When the capabilities of a source are being expressed, the time voltage being understood, the expression may be in amperes and hours, as in the example of a storage battery, rated, say,

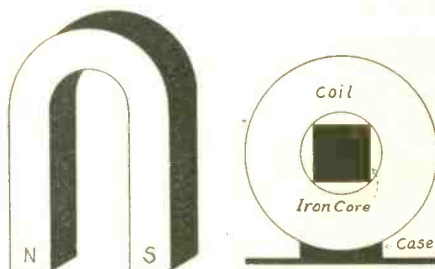

Two types of magnets, permanent (left, represented by horseshoe type) and electromagnet (right). The permanent magnet has fixed poles, called north and south. The electromagnet, which also has attracting powers like the other, has constantly changing poles when a.c. flows through the coil.

at 10 ampere hours, meaning that the battery can store enough energy to produce an electrical value equal to hours multiplied by amperes in actual use, equaling 10. And the current flowing equals 10 ampere hours.

Why Power Is Needed

Whenever anything has to be moved power is required, also whenever any current has to be drawn by a driven circuit, the driver must supply power. In radio sets, as a rule, there are only two places where power is required. Usually it is needed only in the output tube or tubes, therefore called power tubes, as energy has to be supplied fast enough to move a mechanism, since sound is radiated by imparting motion to a diaphragm, to produce the necessary rarefactions and condensations of the air.

The other example of power requirement is where the power tubes themselves draw or may draw grid current, meaning that the grids become positive and thus their tubes should be relieved of the extra drain. Hence the tube ahead of the output stage acts as a driver to supply power to the input circuit of the output tubes. Sometimes, however, a driver in such a

(Continued on next page)

(Continued from preceding page)

position supplies only voltage, because the last tubes are so highly biased negatively, or otherwise operated within cautious limits, as not to cause any direct current flow in the grid or input circuit of the last tube or tubes.

The Pulse in Direct Current

In practically all other receiver uses the only objective is to build up the voltage. This is true of the radio frequency amplifier in a receiver, which consists of those stages that build up the voltage from the low value received at the antenna from the transmitting station, to the high value at the same frequency necessary to actuate a detector tube, or supply a tube that serves a purpose similar to detection, as the mixer or modulator tube in a superheterodyne. In r.f. or intermediate frequency stages these successive elevations, accompanied usually by improvement of selectivity, or the dis-



If a graphical representation is to be made of direct current, it would be a straight line. On the zero axis, left to right, nothing takes place. Somewhat above is the straight line representing current I , at an elevation constant, the time axis being left to right.

criminating faculty between desired and undesired frequencies, all concern alternating current, or a counterpart of a.c., known as pulsating direct current.

As we are principally concerned at the moment with d.c., let us find an analogy that fits the obvious example of simple continuous current and also that special form of direct current that is called pulsating.

Now, suppose that a boy is on his sled, and his father gives him a push, so that the boy and his sled ride a block on a perfectly flat snow-covered pavement. That would illustrate simple continuous current. Suppose there was an undulating hill, and the boy started at the top to coast down, the sled swishing into the small gulleys and topping the low peaks, up and down, up and down. That would represent pulsating direct current. Yet the boy and his sled in both instances would be moving in one direction only, considering the line of path, that is, they would not be coasting down and then equally fast riding up the bumpy hill, back and forth.

Case of the Microphone

The pulses are introduced into a direct current circuit through interruption, complete or incomplete.

Direct current is made to flow through a microphone. Somebody speaks into the microphone and the effect of the sound waves upon the diaphragm is communicated to the granules of a carbon microphone, let us say, and the

resistance of the granules is thereby changed, so that the current, though direct, is changed in accordance with the pressure of the sound waves. An electrical duplicate of the sound waves has been created. We have pulsating direct current, the boy on the sled on the ridgy hill.

The voltage, current, resistance and power in a direct current circuit are related by Ohm's law.

Since the potential drives the electrons, displacing them from their usual orbits, it may be considered as the pump. As the current is what we call the thing that is driven, that would be the water. The opposition that the system offers to any displacement whatever may be called the resistance. From that we may realize that the higher the potential, measured in volts, the more current will flow, for a given resistance. Or, if the resistance is varied, and the potential is constant, the more current will flow, the less the resistance. And the more current for given voltage, or the more voltage for given current, resistance being then necessarily constant, the greater the power, which is the product of voltage and current.

Ohm's Law

However, the power considerations are incidental to Ohm's law, which relates voltage, current and resistance as follows:

The potential in volts equals the current in amperes times the resistance in ohms ($E = IR$).
The current in amperes equals the potential in volts divided by the resistance in ohms ($I = E/R$).

The resistance in ohms equals the potential in volts divided by the current in amperes ($R = E/I$).

For voltage we multiply, and as there are only three factors, one of them the unknown, so we multiply ohms and amperes. For current or resistance we divide, in both instances into the voltage E , and there is only one quantity left to divide into E , so the formulas are very simple, and should be learned by everybody.

Examples Cited

What is the voltage if 20 milliamperes flow through 86 ohms? Write 20 milliamperes as .02 ampere, then the voltage equals $.02 \times 86$ or 1.72 volts.

How much current flows through 66 ohms when the potential applied is 42 volts? Divide 42 (voltage) by 66 (resistance) answer .636 ampere or 636 milliamperes.

What is the resistance when the current is .012 ampere and the voltage is 18.6 volts? Divide the voltage, 18.6 by .012, answer 1,550 ohms.

What is the power in all three instances? It is the voltage times the current, so $1.72 \times .02$, equals or .0344 watt, equals 34.4 milliwatts, in the first instance. In the next example it is 42 times .636 or 26.712 watts, and in the third example is 18.6 times .012, or .2232 watts, equals 223.2 milliwatts.

Even when only voltage amplification is de-

sired, there is power in the circuit, but since the voltage consideration is controlling, and the current is very small, the current is usually not considered. At least the object is to build up the voltage and not the current, indeed, as the voltage rises the current drops proportionately, but current holds not much interest in this application.

Pulsating D. C.

In concluding the discussion of direct current, before turning to alternating current more completely, it is advisable to give more data on the case of pulsating d.c. Despite the wave form affecting it, the current really is and remains d.c. Suppose a circuit were set up so that d.c. flows, and then a fast-working switch were connected in series, so that the current could be turned on and off rapidly. If a coil of suitable electrical dimensions were put in series with this circuit, the steady field present when d.c. flows, a manifestation of electromagnetism, would become unsteady at the rate at which the switch was open and closed, and if earphones were put across the coil the clicks of starting and stopping could be heard. If



If direct current is not steady, as when it is interrupted periodically, or according to a pattern of speech or music, as in a detector tube, then the direct current is called pulsating, and a graphical representation of such current is shown above.

the coil has two associated but mechanically separate windings, both on the same iron core, if the direct current were passed through one of the windings, in series with a microphone into which speech is put, the changes in the electromagnetic field in the directly coupled winding would be communicated by induction to the other winding, and sounds produced before the microphone would have direct current counterparts in the primary circuit. If the secondary, or second winding of the coil, were put into a detector circuit, and earphones connected to output of the detector, the sounds produced before the microphone could be heard in the ear pieces.

Reincarnation of A. C.

What took place was that direct current was put through the microphone, the sound waves striking the microphone produced changes in the direct current, making it rise and fall at the same pace as the original, and of frequencies equal to the original, so that these changes occurring now in the primary of a transformer set up a changing electromagnetic field, which represents alternating current and this influenced the secondary, so that in the secondary only alternating current is flowing. There is no conductive continuity between the primary and the secondary, d.c. can not jump gaps, or

assert itself "in space," as a.c. can, so we have recreated a.c. from pulsating d.c.

That is exactly what is done when a transformer couples the detector tube to the first audio (audible) frequency amplifying tube, a.c. of the speech or music frequency or frequencies is recreated by electromagnetic action. It is true when the circuit has a coil present, but if there is resistance coupling, there is no true a.c. in the plate circuit, but pulsating d.c., and in the grid circuit there is a.c., because of a stopping condenser between plate and grid, the charge and discharge of which condenser produces the equivalent action of that of a transformer, the recreation of a.c. from pulsating d.c. This is really a case of converter action.

The A. C. Wave

When we deal with steady current we talk of "static" values, meaning standing ones, and

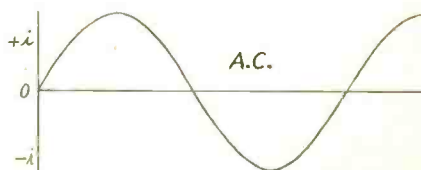

Alternating current (sine wave shown) rises and falls above and below the zero axis. Read time from left to right, current amplitude from zero upward for positive values of i , from zero downward for negative values of i , where i equals the current. The voltage changes at the same rate.

when we deal with a.c. current we refer to "dynamic" or moving values.

Alternating current (or voltage) is one that goes through a complete recurrent cycle. The number of repetitions per second determines the frequency, hence frequency is the number of cycles per second. Half a cycle is called an alternation. There are a positive and a negative alternation. Considering a sine wave, one of uniform shape, the voltage (or current) begins at zero, rises to maximum positive, falls to zero, then repeats the operation in the negative portion or alternation, to equal values but opposite sign.

Therefore rapid reversals take place in alternating current (or voltage). The lowest with which we are generally familiar are the variations at 60 cycles per second of the a.c. line, and the highest in radio practice are the ultra frequencies around 300 megacycles (variations of 300,000,000 cycles per second). In general, the same principles apply, regardless of frequencies.

A. C. Much More Complex

With direct current the situation seems simpler, as a resistance has just one resistance, the current is limited by that resistance, and resistance, voltage and resultant current are computable almost by mental arithmetic. We connect everything directly, using d.c., for there

(Continued on next page)

(Continued from preceding page)

must be continuity through a wire or other metal medium, and the factors are few.

In a.c. we meet an entirely different situation. The phenomenon of electromagnetism uses the ether as a medium of electron activity of considerable import. Resistance we find of various kinds. It isn't direct current resistance, either, as that is usually a small consideration. We find there is such a thing as a.c. resistance, moreover something else expressible in ohms, the reactance, and still something else in terms of ohms, that is, impedance. Also, change of frequency produces change of resistance sometimes, change of frequency produces change of reactance and impedance always. Current therefore changes. In fact, the very cycle itself is one of constant change, from zero to maximum in one direction, then zero to maximum in the opposite direction. We know of condensers in terms of capacity. We find they look to the circuit like certain resistances. The same is true of coils we know of in terms of inductance. A term called power factor rises to implore our attention and understanding. We find ourselves in a vaster field

Action Under A. C.

Perhaps the simplest way to gain a fair understanding of the alternating current circuit is to consider that a voltage is impressed, of a particular frequency, and that in the coil or condenser a certain current then flows. If the voltage is increased, frequency unmolested, the

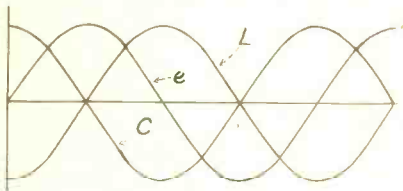

The sine wave represents the electromotive force, or driving agency, of alternating current practice. A pure inductance causes the current to lag behind the voltage, as at curve L. A pure capacity causes the current to lead the voltage, as at curve C. When L and C have such values as to restore the current to the e curve, a single frequency has been introduced and the LC circuit is resonant to it.

current will increase. But if the voltage is held constant and the frequency is increased the current may increase or it may decrease. We notice that something remarkable has taken place, that frequency acquires the influence of resistance, since change of frequency causes change of current. Why is this?

Let us consider a tuned circuit. If a non-resonant frequency is supplied to a circuit consisting of inductance across which is capacity, a certain current will flow through the condenser, another current flow through the coil. If the circuit is tuned to frequency B, and the supply frequency is A, then the currents will be

unequal in the two legs, and there will be a measurable current in a circuit common to both.

Resonance Explained

But if the tuned circuit is changed to be resonant to the frequency of the supply, or B equals A, that is, no frequency difference exists, the current through the condenser will be equal to that through the coil, although opposite in direction at any instant, hence through a common lead connection there will be no current flowing, because equal and opposite values of amplitude simply cancel out. We may then define resonance as that condition where the sum of the currents in the capacitative and inductive branches is zero.

In general, it is this impressive fact that distinguishes a.c. from d.c. practice, that the circuit is sensitive to frequencies, and into it different resistance values are automatically introduced as frequency is changed.

We must therefore consider the components of resistance. In the case of a resistor measured for its d.c. resistance, if the unit is non-inductive and noncapacitative, as a carbon resistor usually is, then the d.c. and a.c. resistance are the same.

Different Resistances

Also, as a general statement, the d.c. resistance of short wire used in coils at low frequencies, e.g., line frequencies, is the same as the a.c. resistance of the wire, but not the same as the a.c. resistance of the coil of which the wire is wound. When just resistance is mentioned in a.c. practice always the a.c. resistance is meant, never the d.c. resistance, because the effect of the d.c. resistance is either negligible or shows up in another consideration, and is practically constant for all frequencies.

Therefore let us find out what the a.c. resistance is. If a pure resistance is put in series with a circuit carrying a.c., and is varied until the current flowing originally is halved by the presence of the introduced resistor, then obviously the coil or condenser a.c. resistance is equal to the resistance of the adjunct. That is a measurement, by the resistance variation method. The a.c. resistance then is the resistance that the coil or condenser offers to a.c., and is practically constant with frequency.

Reactance of Coil and Condenser

We are concerned however with the current changes that take place due to frequency difference. These are based on two factors, one being the reactance and the other, which is all-inclusive, the impedance. The reactance is the equivalent pure resistance of the coil to the particular frequency due only to the coil's inductance. For a condenser the reactance is the equivalent pure resistance of the condenser of given capacity at a particular frequency, based solely on that capacity. Hence reactance relates frequency, voltage and current for the capacity aspect of condensers and the inductance aspect of coils.

Besides the ohmic expression thus obtained, we remember that these units have a.c. resistance, or a resistance to a.c. practically inde-

pendent of frequency. The reactance is reactive, that is, sensitive to frequency, the a.c. resistance is not, except to a small extent.

The All-Inclusive Term

Some expression must combine the effects of the a.c. resistance and the reactance, and any other factors except voltage that enter into the determination of the total current flowing. After all, there must be a cumulative expression, since there is finally a single total current. The expression that reflects all the circumstances that control the current is the impedance. It, too, is expressed in ohms, because it represents an equivalent pure resistance of a certain value, for either coil or condenser, at a particular frequency, independent of voltage. It takes into account without special segregation the a.c. resistance, the d.c. resistance and the reactance.

Pure Resistance Defined

A pure resistance is one that is nonreactive, i.e., has neither inductance nor capacity.

In a.c. practice, assuming a sine wave, the same Ohm's law is applicable, where impedance, Z , replaces resistance R .

The capacity reactance of a condenser is equal to $1/2\pi fC$, where f is the frequency in cycles, π is 3.1416, and C is the capacity in farads. Thus the higher the capacity the lower the reactance, frequency unchanged, or the higher the frequency the lower the reactance.

For inductive reactance it works the other way, since $X_L = 2\pi fL$, where f is in cycles and L is inductance in henries. The higher the inductance, and the higher the frequency, the greater the inductive reactance. All answers are in ohms.

Power Factor

It is well to point out that both the coil and the condenser present a certain pure resistance to a.c. based on the reactance, and that if besides either quantity, the a.c. resistance is known, then the power factor may be computed. This is simply an expression of the merit of the coil in a circuit where efficiency is paramount, as for tuning purposes, and of the merit of a condenser in a circuit where waste of power would be costly. In B filters and radio use generally the power factor of filter condensers is of no consequence, in tuned circuits it is, for both coils and condensers.

The power factor for coils or condensers is defined the same: it is the resistance divided by the reactance. If the fraction is reciprocated—the reactance divided into the resistance—the Q of the coil is obtained. The higher the Q , or the lower the power factor, the better a tuning coil.

New Light on Resonance

We may now reconsider resonance and describe it as unity power factor. The example previously cited indirectly set forth resonance as maximum impedance. Or we may look upon the action more realistically and say that the circuit is resonant when the rate of supply of

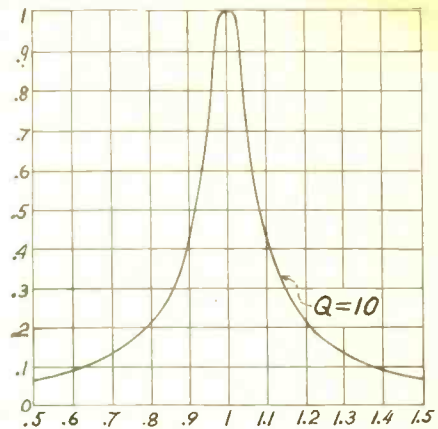

Selectivity curve. From this the Q of a circuit may be computed. Let the ordinates (upright) represent voltages of input, and let the abscissas (horizontal) ratios of frequency. When the resonant voltage is reduced by detuning, to a value .7 either side of the voltage (or current) maximum as represented by resonance at 1, the power factor is the difference, 1.05 minus .95, or .1, and the Q is the reciprocal, or 10.

voltage to the condenser is exactly equal to the rate of discharge of voltage by the condenser through the coil.

We have seen also that at resonance the difference between the currents through coil and condenser is zero. A resonance curve is shown in the illustration herewith.

Operation on Straight Part of Characteristic

Practically all tubes have a straight portion over part of the characteristic, and the two curves given last month for a tube voltmeter disclosed this condition and showed how the 30 tube may be worked as a linear amplifier with 45 plate volts, at stated r. m. s. input, although the permissible grid swing is only half a volt. However, there are many instances where an amplifier stage will get such input, relatively steady.

Curves last month showed the straightness for 45 plate volts, 4.5 volts negative bias, obtains when between 3 and 4 volts r. m. s. input are applied, hence use an a.c. input for the halfway position, 3.5 volts. On the curve for the higher negative bias, 7 volts, the same swing is allowable, for straight line amplification, but the input r. m. s. should be 6 volts. Where full a. v. c. is present these conditions are realizable in practice. A tube voltmeter may be used for measuring the voltage, or the setting may be made approximately right by causing 700 and 630 microamperes to flow, for 4.5 and 7.5 volts negative bias, respectively, assuming plate load of negligible d. c. resistance.

Coils and Their Primaries

High Gain Compared to Selectivity

By Francis X. Hargy

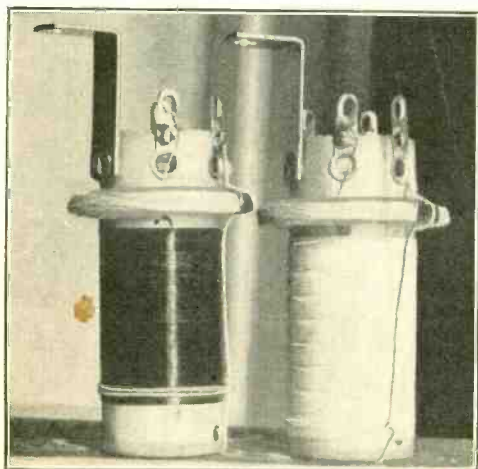

Two antenna coils for unshielded use, exactly the same, except that one secondary is wound of plain enamel copper wire and the other of Litzendraht, a cable of numerous insulated strands.

THE belief is widespread that high impedance primaries should always be used on radio frequency coils because then you get a great deal of gain, which is what you want, whereas with low impedance primaries there is a great and unnecessary sacrifice. The fact lost to sight is that at the radio frequency level it is always impractical to use high impedance primary coils in more than a total of three tuned stages, because of oscillation trouble. If a circuit using three high gain coils has been exceptionally well engineered the results are excellent. Otherwise adhere to two coils. Besides, the selectivity requirement is served by low impedance primaries.

It therefore follows that a receiver using a two gang condenser in a tuned radio frequency set, on a three gang condenser in a superheterodyne circuit, permits the use of high impedance primaries and the principal advantage is derived by those who live many miles from the nearest broadcasting station. Then of course the selectivity requirement is not so exacting, because the carrier voltage input to the antenna winding of the first coil is low.

So Much Volume!

Ability to tune in one station individually, to the exclusion of all others, which represents the attainment of practical selectivity, therefore depends considerably on the location. If

there are strong input carriers from locals, then the demands on the receiver become exacting, especially as cross-modulation may set in.

But in the open spaces, far removed from stations, the high impedance primary coils in the types of receivers mentioned, with the limitation as to number of coils as stated, serve an excellent purpose, and cause many persons unfamiliar with radio to wonder how "such a small set can deliver so much volume." The reason is that, circumstances permitting the use of high impedance primaries, the voltage built up across these primaries is very large. It is not unusual for the primaries to have a greater number of turns than the secondaries, so that the secondary voltage is less than the primary voltage, but there is plenty to spare, and the secondary is much more highly voltaged than if a low impedance primary coil were used.

One at a Time, Please!

So great is the effort to improve sensitivity in a very small set that the antenna primary may be a honeycomb type coil, now more familiarly called universal wound, with an inductance of several hundred microhenries, or about twice as much inductance as the secondary for the standard broadcast band. The primary of the interstage coil may be of even more generous proportions, a few millihenries inductance. In general, the goal is to keep the natural period of both primary circuits below the lowest broadcast frequency, to avoid an erratic working characteristic, which would cause the set to "spill over" through part of the tuning span.

Naturally such large inductance primaries present a high resistance to the high carrier frequencies of the standard broadcast band, therefore the selectivity, which declines anyway in this region, drops very markedly. Persons living in cities then find that stations above 1,200 kc or so, to the high frequency end of the broadcast band, may be heard all at once, no matter where the dial is positioned between these intended limits. That is one of the drawbacks that accompany high impedance primaries on tuned radio frequency sets used in cities in station congested areas. With a superheterodyne this nuisance is eliminated, because the selectivity of the intermediate amplifier is, or should be, sufficient to enable one to bring in one standard broadcast band station at a time.

More Tubes for More Gain

Therefore the radio frequency resistance of the coils having high impedance primaries is high, as attested by interference trouble at the

higher frequencies particularly. Means are therefore provided to put in a great deal, first at the antenna coil, next at the interstage coil's primary, and the evils enumerated have to be countenanced, or the set used in a location that itself tends to remove the evils.

Far more generally used are the low impedance primary coils. These make for greater selectivity, of course. Also, gain may be provided to any required level by using a sufficient number of stages. In a tuned radio frequency set three coils and a three gang condenser enable feeding a conventional audio channel to produce an overall sensitivity of 10 microvolts per meter. With a four gang condenser and four coils, where close shielding and careful radio frequency filtration are necessary, the sensitivity may be developed to as great a height as in any superheterodyne, since one readily reaches the noise level, which represents the limit. Beyond that the noises originated in the set and outside the set become greater than the signal itself, which robs listening of all its enjoyment. A sensitivity of 5 microvolts per meter is considered as great as it is practical to have, and a tuned radio frequency set may attain that readily.

Extra Gang for Super

As for selectivity, that is not so readily produced in a t. r. f. set, because the more stages the more gangs on the tuning condenser, and when there are four gangs, the difficulty of having them track perfectly is considerable. That is one reason why three gang condenser sets are more popular for t. r. f. use, although in supers a four gang condenser may be used to the same tracking advantage because the fourth section operates at capacities purposely displaced from those the capacity of the other sections, hence the problem resolves itself to about the same level as the use of a three gang condenser in a t. r. f. set.

To be readily workable the t. r. f. set should be stable and not pop into oscillation when one tunes through the band with the volume control all the way up. The cause of oscillation is the feeding of energy from a later circuit to an earlier one in such a manner as to augment the energy in the earlier circuit to which later one should contribute nothing. That is, the feeding is done backwards, whereas only forward feeding is desired. If the feedback were closely under control the receiver could be adjusted carefully so that it would operate just below the oscillation point, representative of greatest possible sensitivity. But such fine control is not practical in a receiver in which the feedback is really accidental. The circuit oscillates with a control at one position, and for a slightly different position dips far below oscillation when the control is turned just a bit. That prevents regenerative action, which represents oscillation of a degree just below that where actual generation or production of radio waves begins. An oscillating receiver is producing radio waves, is a possible source of severe interference, and is doing what was never intended that the receiver should do, i. e., act as a transmitter.

Therefore the high impedance primary coils in multi-stage r. f. circuits are by their very nature of large voltage producers serious causes of practically uncontrollable oscillation. Many service men have close familiarity with this problem, solved by replacing the coils with the low impedance primary type. Whether the large primary is only capacitatively coupled to the secondary by the condenser effect of a turn or two of wire leading from the primary and put

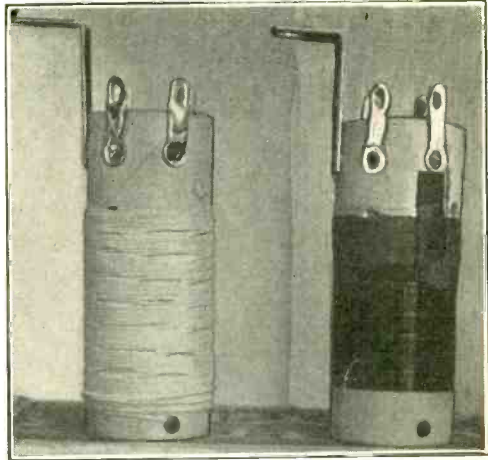

The Litzendraht secondary (Litz for short) has high impedance primary, a honeycomb inside, hence not visible. The enamel secondary coil is of the low gain type.

around the secondary, or inductively coupled, or both, the trouble and cure are the same.

Solution of Difficulty

A compromise may be established in a small set by having the antenna primary of a high resistance, high inductance type, because the greater the r. f. resistance in the antenna circuit the less the tendency to oscillate. Then the interstage coil may have a very husky winding on the primary, and with a two-stage system (two-gang condenser) there would be no oscillation.

The figure of merit of a coil is its Q , which represents a ratio, the reactance divided by the resistance. The reactance represents the limiting effect of the inductance, alone on the current in the coil circuit at some particular frequency. The a. c. resistance is the limiting effect of the coil on the current, independent of the inductance. The reactance therefore depends on frequency and on inductance. The a. c. resistance is practically independent of both. Hence if there is a great difference in current with small change of frequency, voltage constant, the coil will be classed as a good one. The higher the a. c. resistance, the less will be the change of current with frequency, so the a. c. resistance limits the merit of the coil.

Figure of Merit

The high impedance primary type coils, since
(Continued on next page)

(Continued from preceding page)

there is not a great change of current with frequency, are not high Q coils, though they do produce large voltage transfer because of the special pains taken for loading the antenna and plate circuits, or, in some instances even overloading those circuits. If the coupling is rather close, which means that the secondary and the primary tend to have more or less the same electrical identity, then the coil resistance immaterial to the plate circuit of the tube shows up strongly as a resistance effect on the secondary, where resistance is a great deterrent to selectivity. In fact, selectivity is merely a comparison of the tuned circuit resistance at one frequency to the resistance at other frequencies.

The coils with moderate or small primaries therefore yield a better figure of merit, and in the theoretical sense, which practice verifies, are better coils, though for circumventing special difficulties of ruralites who want only very small sets, the high impedance coils serve a real purpose, without of course being any better, as coils, in one location than in another.

Smaller primaries make for looser coupling, and the looser the coupling the greater the selectivity, other factors being equal.

Effect of Shielding

If only a two gang condenser is used on any set, it is not necessary to shield the coils. In fact, a certain increased resistance accompanies shielding, and the shields in small sets that otherwise are stable reduce sensitivity and selectivity and offer no real advantage in return. A certain small amount of feedback, not enough to produce oscillation, may be present due to absence of shields around the coils, but in modest sets this feedback is virtuous and valuable. In larger sets, with more coils, hence greater enlargement of r. f. voltage, the back coupling becomes far too strong, hence is a vice and useless. So shields must be used in larger sets, and shields grounded.

In theory the shielded coil does not have as high a Q , for the inductance is reduced a little by shielding, and the capacity and a. c. resistance are increased, all working toward reduction of resultant voltage. But shielding renders the set workable, whereas without shielding it would be unworkable, so the shields not only bestow a net benefit but are practically imperative in multistage sets.

Position of Coil in Shield

If the shield is too close to the coil, either at the side wall or top and bottom, the resistance of the coil increases greatly. It is advisable to have a shield, if cylindrical, of at least twice the diameter of the coil, and to center the actual winding inside the shield both side to side and up and down.

When a channel is operated at a fixed frequency, as at the intermediate frequency of a superheterodyne, then an entirely different condition obtains, and the objective is to establish high impedance circuits. The impedance is the combined effects of all the agencies in the circuit to limit the current when an alternating

voltage is supplied to the circuit. The impedance is therefore the balance sheet of the circuit constants, or a test after whole performance, whereas the reactance is a test of one act.

Since practically in the power tubes alone, used for audio output, is power desired at carrier or modulation frequencies, and only voltage amplification desired prior to the output stage, the higher the impedance, the lower the current, since product of current and voltage remains about the same. The low current is matched with a proportionately high voltage, and we have the gain we seek.

Primary and Secondary Tuned

Hence intermediate transformers are tuned in both primary and secondary circuits, and in some of the newer types used in commercial sets, a third winding in the same shield also is tuned, for greater selectivity and gain. When the channel is closely tuned the selectivity is highest, the gain is greatest because the a. c. resistance that tends to limit the circuit gain is lowest.

We do not have to tune the i. f. over a wide band of frequencies, therefore the channel may be stabilized at the single frequency, so that no oscillation is present whatever, for even a little of it would result in a squeal every time a station was tuned in. If any such effect of signaling the presence of a station is desired, a separate tube is made to oscillate at the i. f., and a little of its voltage is delivered to the second detector. Otherwise i. f. oscillation is not wanted.

The coils at the i. f. level are subject to the same comparison of resistance divided by reactance, or the Q enters here the same as elsewhere, and may be increased by using special iron cores, loose coupling, or more favorable winding methods, such as having a series of equal and connected universal wound coils with a space between each.

Effect of Pie Winding

This method is called pie winding and it reduces the distributed capacity of the total inductance, compared to a single wound universal coil, but distributed capacity is of no consequence in a circuit where the tuning capacity across the inductance is usually 100 mmfd. or more, and sometimes more than twice that.

The increase in the Q is what prompts the use of pie wound intermediate coils, although this is not the only factor to consider. Equally important is the fact that the condenser across the coil should be of the type that holds its capacity adjustment well.

Although frequency change at the i. f. level is not of very great importance, as 1 kc change of i. f. represents a change of tuning in the mixer level, any band, of only the same amount, 1 kc, nevertheless the change may be of different degrees of capacity and even in different directions, so mistuning, which reduces sensitivity greatly, and selectivity somewhat, results. Hence air dielectric condensers are

(Continued on next page)

Layout and Wiring

Vastly Important for Short Wave Sets

By Stephen Masters

Thor Radio Company

AS all set builders know, not all receivers wired according to the same diagram work the same way. Some work excellently while others may not even work at all. What is the reason for this wide difference? Or, rather, since it cannot all be ascribed to the same cause, what are the reasons?

Of course, one reason is the unavoidable difference in the component parts. Commercial tolerances in radio parts are wide and therefore large differences in receivers built from

these parts may be expected. Then, besides, there may actually be defective parts, components which even do not meet the manufacturer's tolerances.

The main reason, however, for the wide divergence in radio receiver performance is differences in layout of parts and of wiring. It would seem that commercial receivers built to the same specifications would be exactly alike in this respect, but they are not, for small, yet

(Continued on next page)

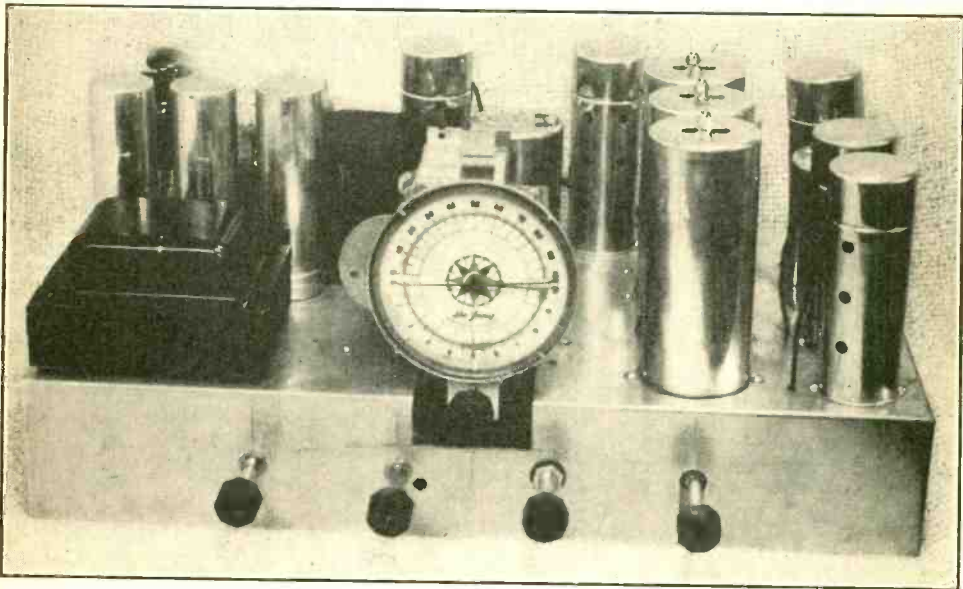

The controls from right to left are coil switch, volume, line switch, tone. The r.f. and oscillator coils are in the three shields in next row from right.

COILS SHOULD BE SUITED TO INTENDED CIRCUITS

(Continued from preceding page)
preferable, and pie wound i. f. coils usually have compression type condensers.

Two or Three Coils

Another consideration is that the Q of the coil need not be so high that the small inherent feedback is raised to troublesome proportions. When three i. f. coils are used (two tube stages) the standard universal wound coils usually yield all the amplification the circuit will bear, and improving the Q by pie winding would not accomplish enough to permit the use of only two coils (one tube stage) for the same

results, and therefore the coils for two-stage channels are more or less suited to the circuits in which they are to be used. The fact that there is approximate standardization of i. f. coils into two or three types simply means that the i. f. circuits themselves are standardized to the same extent.

It is therefore apparent that coils should be suited to the circuits they are to serve, should have low impedance primaries for radio frequency levels if selectivity is of importance, and at intermediate frequencies should produce maximum gain and selectivity consistent with stability with standard voltaging of tubes.

neath view of the chassis indicates how the circuit has been laid out to avoid doubling back. The circuit starts with the tuner of the first r-f. amplifier tube in the right front corner. Then it proceeds in a line to the rear. At this point the i.f. amplifier begins and runs in a straight line toward the left. At the left end

been grouped in shielded cans. A great deal of the wiring has been done inside of the cans, and since the cans are not very large the internal leads are necessarily very short. Besides this they are shielded from the leads in other cans as well as from the leads outside the shields. These shielded, multi-band commercial

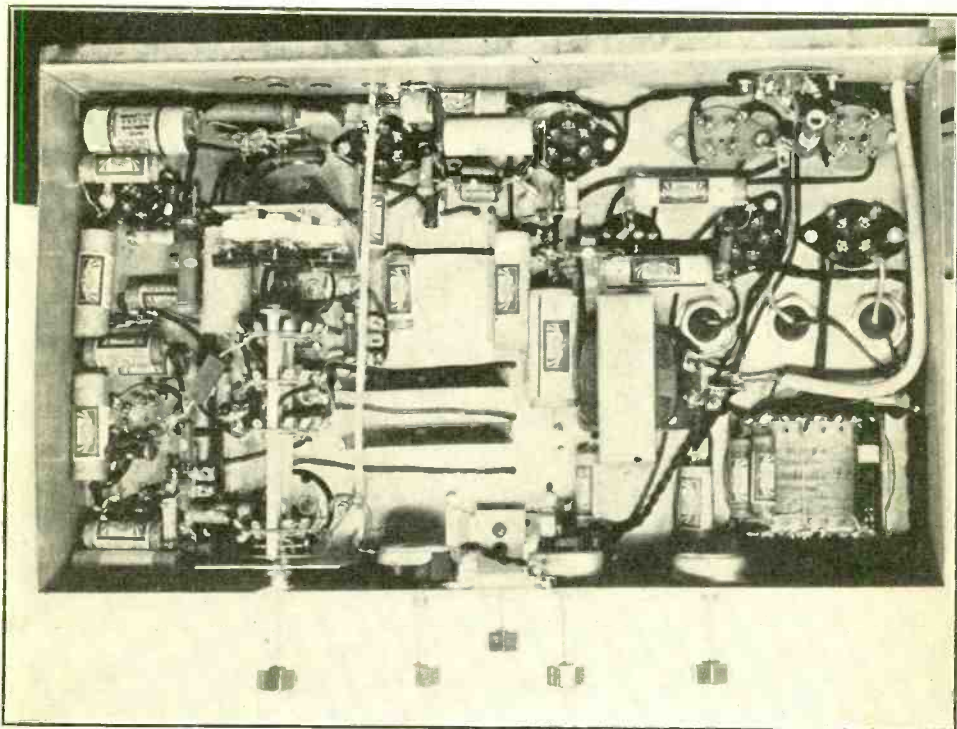

Now the direction is reversed due to the underneath view. Controls are now, left to right: coil switch, volume, line switch, tone. Note ship-shape layout of parts and careful wiring.

are the audio amplifier and the power supply. The audio amplifier is at the rear.

Of course, this layout has become more or less conventional just because there is little chance for doubling back of leads. But the broad outlines of the circuit according to this scheme are not enough to insure freedom from oscillation. If the tube sockets are placed in a given way, long leads and doubling back may be unavoidable, whereas if the sockets are mounted in another way, the leads may be short and direct.

The same thing applies to some extent to the coils. That coils and sockets have been placed correctly cannot be seen from the top-view photograph of the receiver, but can be on the bottom view photograph. There are hardly any leads visible at all. That is a good sign, not only of good design in the first place but also of expert wiring in the second place. All connecting leads necessary are there. If there were more connecting wire, it would be superfluous and likely to cause trouble.

The multi-band tuner in this set has been greatly simplified by the fact that the coils have

coil assemblies solve one of the most difficult problems of building multi-band receivers.

Simplification of wiring is also effected by the fact that gang switch by which the various coils are selected is mounted directly under the coil shields. Thus the leads from the coils emerge from the cans and go directly to the switch points. The three decks on the gang switch are spaced approximately the same as the coils with which they are connected.

There are only two excessively long leads, and they are the grid leads for the first two tubes. They must come from the condenser stators directly or from the switch points connected to the stators. To run these leads on top would make the very long indeed. Therefore they are run from the switches to the grid caps. The two leads may be seen in the picture on page 21. The leads could be run inside the tube shields if necessary, or they could be placed so that a tube shield is between them.

The reason they are placed outside the shields in this case is that it was desirable to keep the minimum circuit capacities down to the lowest possible values.

An Audio Beat Oscillator

Two Heater Triodes in Hartley Rig

By Louis Kranz

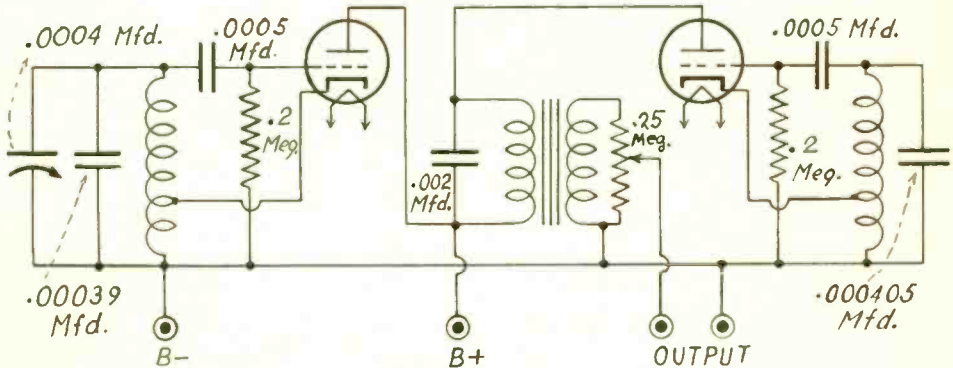

Two equal oscillators are established for one frequency. They are not shown coupled by any particular method, but it is scarcely possible to avoid sufficient coupling due to common supply. One of the oscillators is varied in frequency and the resultant beats come out as constant amplitude audio tones. The range intended is 100 to 17,000 cycles.

HERE is a way to build an audio oscillator. Set up a radio frequency oscillator to cover a low radio frequency range. Use the familiar tuning condenser shunted by a capacity about equal to its own. Then set up another radio frequency oscillator, but of fixed frequency. Set this equal to the highest frequency generated by the other. For coupling the two radio frequencies, to produce the audio tone due to the difference between the others, don't couple them intentionally. The problem is to get the coupling weak enough. So make believe there is no r.f. coupling, and yet there will be enough, and the audio output may be taken through a transformer, using secondary as output.

Now as for calibration. The variable frequency oscillator has to be calibrated and a chart is prepared, so the audio frequencies may be set down as the differences. Or if a direct radio frequency reading dial is used, the audio tones may be read as differences.

Spreadout at Right End

Suppose that with the fixed condenser across the variable and about equal to it, the frequencies generated are 83 to 99.9 kc. If the fixed frequency oscillator instead is made 100 kc, then the reading on the other, subtracted from 100, will yield the audio frequency.

It so happens that there is great spreadout, or bandsread, at the lower capacity settings of the variably tuned arrangement, so that, starting with 100 cycles, which is low enough, the direct readings are in steps of 100 cycles to

1,000 cycles, and from 1,000 cycles to 17,000 cycles the bars or divisions are in steps of 500 cycles. This yields a very extensive range, 100 cycles to 17,000 cycles, and enables checking at all the standard frequencies, as well as many others, and at a level practically the same for all.

Looking at the diagram, the condenser at left is the variable one. To track a calibrated dial the condenser must be of a particular type or make, and of course capacity. At right the circuit is duplicated with what amounts to fixed capacity across the coil.

The coil that is tuned by either arrangement happens to require an inductance of 3 millihenries, and have a tap for the Hartley type oscillator.

Same Coil Duplicated

Now, looking at the other or right hand side, we find the same inductance coil, and a fixed capacity equal to the capacity of the other circuit at minimum. What capacity is in the left-hand circuit that is not in the right, when the left-hand one is at minimum? Why, only the minimum capacity of the variable, which may be 15 mmfd. So the right hand fixed capacity would be equal to that of the left hand fixed condenser plus the minimum of the variable, or, .00039 plus .00015 or .000405 mfd. Actually, the right hand fixed member is built up of a fixed and a small variable in parallel, so that adjustment for zero beat may be made.

If you are starting out anew, and are to cali-

LIST OF PARTS

Coils

Two tapped honeycomb coils, inductance 3 millihenries.
One audio frequency transformer, secondary used as output.

Condensers

One variable condenser, 15 to 400 mmfd.
Two .0005 mfd. mica fixed.
One .002 mfd. fixed.
Fixed capacities, or fixed and a variable, to comprise just the right amount to zero beat with variably tuned circuit. Shown as .000405 mfd.

Resistors

Two .2 mag. 1 watt.
One .25 meg. potentiometer.

Other Requirements

Two octal sockets.
Four output posts.
Source of 6.3 heater voltage, a.c. or d.c. transformer or 350 ohm, 30 watt line cord may be used on line a.c.; or line cord on line d.c.; or 6 volt storage battery; or four No. 6 dry cells in series.
Source of B voltage (must be 45 volts at least; should not exceed 250 volts).
Baseboard panel.
Frequency calibrated dial, escutcheon.
One knob.

brate your own oscillator, even protract the calibration to make it direct reading, then you establish zero beat, after the variable radio frequencies are measured, and the fixed second frequency is then known, the audio representing the differences. The object is to try to get rid of the necessity of using audio frequencies for any measurements or comparisons, even though the direct way may be used rather extensively from the stations on the air, as explained in an article on page 44 of the January, 1936, issue, and answer to a question on page 57 of the same issue.

However, assume that we do not know anything about the frequencies, radio or audio. The first thing to do is to put a condenser across the nominal .0004 mfd. tuning condenser about equal to itself, and use an inductance around 3 millihenries. The highest frequency will not be far removed from 100 kc, and the lowest not far removed from 83 kc, so tune in a station on a broadcast set (preferably t.r.f. type) the frequency of which is a multiple of 100 kc.

How Stations Are Used

Suppose the station is 1,000 kc. Then the tenth harmonic of 100 kc would be heard beating with the station, and the frequency of the fundamental would be 100.

Using the same station, the next lower frequency would be 1,000/11, or 90.9; next, 1,000/12, or 83.33 kc. Or if 1,400 kc were being used, the fourteenth harmonic of 100 would beat with 1,400, the other frequencies fairly within range being $1,400/15 = 93.33$ kc; $1,400/16 = 87.5$ kc, and $1,400/17 = 82.94$ kc. So we may set the variable oscillator to zero beat with 1,000 kc at 90.9, and, using numerous broadcasting stations of known frequencies, plot a curve, which will represent dial settings against generated frequencies, and then we may set the fixed oscillator to zero beat with variable one, being sure we are using the fundamentals. This may be checked on the receiver by noting the frequency differences thereon from each oscillator alone.

Ascribe instead of the radio frequencies, the difference frequencies between the fixed and the variable oscillators. These differences are audio frequencies. It is not pretended that the higher audio frequencies of the spectrum produced can be heard, but anything below 20,000 cycles is commonly classified as an audio frequency, at least ruled out as a radio frequency.

Differences Read from Dial

If the dial is frequency calibrated the adjustment for a particular frequency may be made on the basis that 100 kc will not be quite reached, so adjust a trimmer on the variable so that a beat is obtained with a station and the tenth harmonic of the generator, 97, 98 or 99, for stations of 970, 980 or 990 kc, or use other sub-harmonics of other stations, e.g. 87.5 for zero beating with 1,400 kc, as previously outlined.

Then with the calibrated dial set at minimum capacity, and reading 99.9, zero beat the fixed frequency oscillator with a station of frequency divisible by 100, and then the difference between the reading and 100 will yield the unknown in thousands of cycles. e.g. 99.9 from 1,000 kc equals .1 kc, equals 100 kc. One soon becomes familiar with the method, 99 equals 1,000 cycles; 98.5 equals 1,500 cycles; 92 equals 8,000 cycles, etc.

In this way you have a pretty good audio oscillator. The output may be subject to attenuation. A potentiometer of 250,000 ohms may be used for general practice. Earphones may be put in place of the transformer primary if one is simply desirous of listening to the frequencies. Or, earphones may be connected across the secondary, with the transformer included.

The Accustomed Purposes

The most usual purpose would be to connect the output to the input of an audio amplifier, and watch an output meter to determine the relative responses at the difference frequencies. Since the amplitude is relatively constant for the generator any change may be ascribed to the amplifier. Or the audio tone may be used for modulating a radio frequency oscillator.

I.F. Channel Without Coils

Used in Five Meter Superheterodyne

By Frank Lester

Wholesale Radio Service Co., Inc.

A SUPERHETERODYNE for five meter reception can be almost as simple as a straight super-regenerative receiver and will give superior results insofar as sensitivity, selectivity and noise level are concerned. The absence of "rush," that noise characteristic of super-regenerative receivers, will especially appeal to amateurs. The set is known commercially as the Lafayette.

A superheterodyne that the amateur can build himself without much difficulty is shown in the accompanying diagram and illustrations. Six tubes are used exclusive of the power rectifier.

The circuit comprises a stage of tuned radio frequency amplification, a tuned autodyne detector, two stages of resistance-capacity coupled intermediate frequency amplification, second detector and semi-automatic volume control tube, and a power pentode output stage capable of working a dynamic loudspeaker. The entire unit can be built onto a compact copper-plated chassis, measuring only 11 by 7½ by 2¼ inches.

Separate Tuning Controls

To simplify the arrangement of the parts and to eliminate trimming and aligning troubles, separate controls are provided for the radio frequency and detector stages. While the radio frequency stage admittedly does not provide a great deal of amplification, it does improve the signal-to-noise ratio and, more important, it eliminates receiver radiation and dead spots in the detector tuning due to antenna absorption. The first detector works on the autodyne principle, the grid circuit being detuned a trifle from the signal frequency so that a comparatively low frequency beat develops. This simple method of obtaining heterodyne action is quite practicable on the ultra-high frequencies.

Feed back between the grid and plate of the first detector is obtained by the use of a small radio frequency choke in the cathode circuit. This choke is common to both the grid and the plate circuits and therefore oscillation is maintained at a steady rate. The grid condenser-leak combination and also the screen and plate voltages are adjusted to give smooth feedback but not super-regeneration.

Strays Not Amplified

The use of resistance-capacitance coupled i.f.

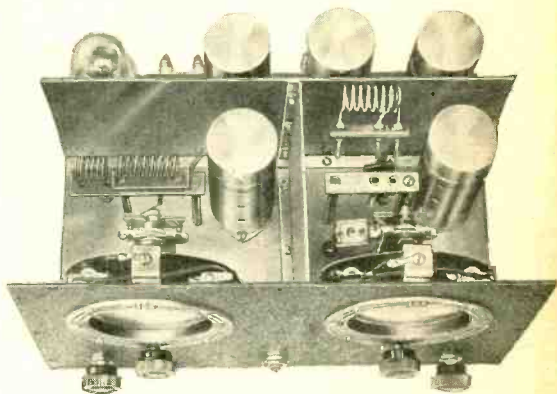

Top view of the five meter receiver.

greatly simplifies the construction of the receiver. There are no magnetic fields or interaction effects and shielding necessity is therefore minimized. The grid coupling condensers are of such low value, comparatively, that the i.f. system does not amplify stray impulses.

The i.f. circuit responds to frequencies from about 15 kc to about 100 kc.

A type 41 tube, screen and grid hooked together to form a high mu triode, is used as the second detector. Part of the rectified grid current is taken off the grid leak and returned to the grids of the intermediate frequency tubes, to give automatic volume control action and to prevent overloading on extremely strong signals. The second detector is resistance-capacity coupled into a 42 pentode with a grid leak potentiometer volume control.

Five Meter Coil Data

Careful bypassing of the radio frequency tube elements is necessary to prevent the radio frequency signal energy from getting lost in the power supply leads. One side of the first detector heater is grounded as near the socket as possible, while the other side is bypassed to the same point by a .01 mfd. fixed condenser. The screen bypass condenser must also be installed very close to the socket.

The coils L1L2L3 for five meter operation consist of eight turns of No. 14 wire, ½ inch in diameter, spaced about ⅛ inch apart, and are self-supporting. Bus bar will serve nicely. These coils are mounted on bases which plug into jacks. Various methods of coupling the

antenna to the receiver may be tried. If a two wire feeder system is used it may be connected directly to the antenna coupling coil, or one feeder may be grounded and the other run up a turn or two on the radio frequency grid coil. Single wire lines should be connected to the grid of the radio frequency tube through a 10 to 30 mmfd. trimmer condenser.

If the 6.3-volt tubes are used (6D6 for the radio frequency position, 6C6 first detector, 6D6 intermediate-frequency, 41 second detector, 42 output), the receiver may be used interchangeably on 110 volts a.c. or a storage battery.

Color Code on Fixed Condensers

A color code is useful for the capacity marking of mica condensers for manufacturers' use.

The code includes the use of a distinct color for every numeral from zero to nine, inclusive. The colors are those adopted as standard in the Radio Manufacturers Association's Resistance Code, as follows:

Numeral	Color	Numeral	Color
0	Black	5	Green
1	Brown	6	Blue
2	Red	7	Violet
3	Orange	8	Gray
4	Yellow	9	White

A prerequisite to the use of this code is that capacity first be expressed in terms of micro-microfarads, as .00025 mfd. = 250 mmfd

The three color rings on the face are used as follows: reading from left to right:

1. The first dot indicates the first digit.
2. The second dot indicates the second digit.
3. The third dot indicates the number of zeros which appear after the first two digits.

Examples:

.000025 mfd. = 25 mmfd. = Red	Green	Black	Black
.00005 mfd. = 50 mmfd. = Green	Black	Black	Black
.0001 mfd. = 100 mmfd. = Brown	Black	Brown	Brown
.00025 mfd. = 250 mmfd. = Red	Green	Brown	Brown
.0005 mfd. = 500 mmfd. = Green	Black	Black	Brown
.00075 mfd. = 750 mmfd. = Violet	Green	Brown	Brown
.001 mfd. = 1000 mmfd. = Brown	Black	Red	Red
.01 mfd. = 10000 mmfd. = Brown	Black	Orange	Orange

The above covers practically all requirements, but if three numbers exclusive of zero appear in the capacity, such as 1250 mmfd., then the marking is as follows:

1. The first two digits are indicated in first and second dots, as usual.
2. The third dot is left blank, which indicates remaining code is on the reverse side of condenser.
3. Use is then made of the two code rings on the reverse side of the condenser from the trademark, the dot on the left indicating the third digit, and the dot on the right indicating the number of zeros which appear after the first three digits, as

.00125 mfd. = 1250 mmfd. = Brown	Red	0
	Green	Brown
.000375 mfd. = 375 mmfd. = Orange	Violet	0
	Green	Black

Constants for Five Meter Superheterodyne

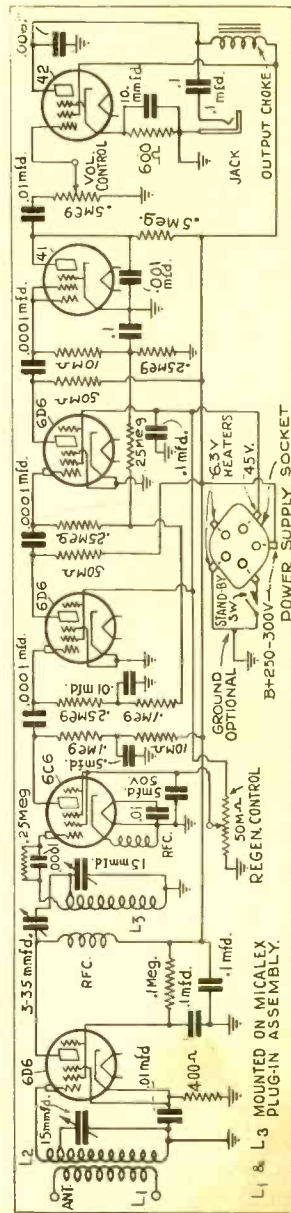

The bandwidth of the intermediate frequency amplifier is 15 to 100 kc. The i.f. is developed by offset tuning of the first detector.

frequencies, since a bypass condenser is intended to prevent any such possibility, even though the higher frequencies referred to are beyond audibility.

The Unconventional Circuit

Looking into the Genetester from the first tube, radio frequencies are handled. Looking out of the first tube in the direction of the post at top left, radio frequencies are put in. The audio tones are directed only toward the speaker.

Therefore the second tube is the detector. The third is an audio amplifier, but not used in conventional manner. Notice that the third tube is coupled to the prior tube directly. There is no stopping condenser. The diode load resistor of the second tube is also the grid leak of the third tube.

Considering the third tube, the audio frequencies appear across the grid leak and are amplified in the tube.

When the audio voltage rises on the grid of the third tube the plate current through that tube drops.

Since the plate current's net effect is that of decrease with signal, the voltage difference across the load resistor in that leg is decreased and it may be reduced to zero. That stops transmission.

If the third tube is normally biased for amplification it will serve as an amplifier, and its output may be taken through the usual resistor-condenser combination, for input to the grid of the power tube. This grid, by the way, is connected to a negative voltage by having cathode grounded, grid picking up a tap on the speaker field that acts as filter choke.

A promise was made that the method of zero beat reception would be given more detailed attention.

Comparative Audio Amplitudes

Every one who has had any experience with audible beats from two radio frequency oscillations knows that the resultant note, considering the audible range, is quite loud. If the beat is between a generator and a station being received on a set, the beat is often loud enough to drown out any other modulation, that is, the program. If the average program modulation is 30 per cent., the audio output when station alone is tuned in is of a certain average value. If a beat is produced that is within the audible range, then the audio output is of a far greater amplitude.

This may be confirmed by reducing the station reception to a weak value, so that when one walks to the other end of the room the station can not be heard, yet when oscillation voltage is mixed with the station carrier, the sound or squeal may be heard at the far end of the room. Both this and the fact that the squeal readily may kill off the program confirm the much greater audio amplitude of the squeal, compared to the program. This is because the squeal is the result of additive voltages. If, in effect, a single carrier is considered to exist despite the beating the local

oscillation voltage is very strong compared to the field strength of the station's wave, so the carrier has been augmented greatly.

Change in Percentage Modulation

Also, beating is the introduction of an original modulation on the combined carriers, or single carrier as we may consider the mixture, and of high percentage. The station modulation alone is of low average percentage, since 100 per cent. modulation, that some stations have, expresses only that the capability of the transmitting system is 100 per cent. for modulation, to take care of sudden, loud passages, yet the average may be about 30 per cent.

When the mixture results in practically a unit carrier, since the station program constitutes only 30 per cent. modulation of its own carrier, naturally the percentage modulation for the new condition of the single resultant and augmented carrier is much less than 30 per cent. This is another reason why the station modulation is readily drowned out by the squeal.

The Startling Disclosure

Now note what is done about this. The audio amplifier 6C6 is the key. Since the modulation due to the station results in a low amplitude of audio voltage, and the modulation due to the beat is far greater, the third tube may be given a little starting bias, as is done in the diagram, and any bias due to the audio amplitude would be additional. Therefore if the tube is of the sharp cutoff type, the biasing may be so arranged that for all audible values of beat, since these are very large, the third tube becomes biased to cutoff of plate current; in other words, there is no drop in its plate load resistor, hence no output. This would wipe out the squeals on timing the set and leave only the station modulation as an audio frequency present in the amplifier, so that the station always is correctly tuned in only when it can be heard. Otherwise, nothing should be heard.

The condition of normal bias would exist only at what passes for zero beat setting of the local oscillator in respect to the frequency of the station carrier, that is, no, or practically no, difference in frequency between the two.

It Has a Great Future

The zero beat method of reception is one of the earliest ones using vacuum tubes, but the method of eliminating the squeals, and permitting only the modulation to come through, is new. It opens a practical field of zero beat reception that is bound to grow, develop a variety of circuits to produce the desired result, and become a permanent addition to recognized methods of reception. If the squeals can be successfully eliminated, the method offers possibilities of comfortable reception, the greatest practical selectivity and the highest sensitivity, all compatible with few tubes, as the receiver proper consists of only two tubes, the oscillator and the squelcher, the three others being merely audio amplifiers to enable speaker operation, and rectifier.

Scouting Foreign Stations

Can Be Done With One Tube Set

By H. G. Cisin

FOREIGN reception is a thrilling reality, not reserved exclusively for owners of high priced multi-tube sets, but available to anyone who invests several dollars in a suitable kit of parts and spends an hour in wiring.

Strange as it may seem, a one tube radio set employing a properly designed circuit, can bring in as many distant stations as a sixteen tube set. Merely adding more tubes most emphatically does not increase distance-getting ability.

This fortunate fact makes foreign reception available to all, even those of most modest means.

The writer has been experimenting for a number of years with this thought constantly in mind—to produce a really efficient low priced all wave radio receiver, simple in construction but powerful and sensitive enough to reach out and bring in European and Asiatic broadcast stations.

Tells of Stations Heard

The following is an authentic list of stations recently received on a simple battery-operated one tube regenerative receiver designed by the author: ZEBT, Mexico City, Mexico; HJ1ABG, Barranquilla, Colombia; 0A4AD, Lima, Peru; TGZ, Guatemala City, Guatemala; YV5RMO, Maracaibo, Venezuela; HJ1ABB, Baranquilla, Colombia; YV3RC, Caracas, Venezuela; HJ3ABF, Bogota, Colombia; DJA, Zeesen, Germany; DJB, Zeesen, Germany; DJC, Zeesen, Germany; COH, Havana, Cuba; GSB, Daventry, England; CT1A, Lisbon, Portugal; COC, Havana, Cuba; PRF5, Rio de Janeiro, Brazil; XDU, Honolulu, Hawaii; FYA, Pon-toise, France; 12RO, Rome, Italy; Prado, Rio-bamba, Ecuador; HJN, Bogota, Colombia; EAQ, Madrid, Spain, VE9G, Bowmansville, Ontario, Can.; T1EP, San Jose, Costa Rica; HJ4ABB, Manizales, Colombia; LR5, Buenos Aires, Argentina and JVT, Najari, Japan.

When first made available to the public several years ago, small all wave kits required an expenditure of \$5. Now such kits are available in junior models for less than half this amount.

What the 30 Tube Is

As in every radio receiver, the heart of the kit is the tube. In this instance, the new type two volt 30 tube has been selected—first because it is effective when properly utilized; second, because its low current drain permits months of use without battery replacement; third, because it will work well with just a few inexpensive batteries, and finally, because it requires but a relatively few associated components, thus simplifying assembly and wiring of the receiver.

For the benefit of the beginner, the 30 type tube consists of three elements contained within a glass envelope from which practically all the air has been evacuated. The elements are known as the plate, the grid and the filament. There are four contact prongs. The two larger prongs connect to the filament within the tube, while one thin prong connects to the grid and the other thin one to the plate.

Two types of batteries are required to energize the 30 tube. The first is known as an A battery. Its function is merely to heat the filament to the correct operating temperature. For this purpose two small flashlight cells connected in series will do very well. Of course, two bell ringing dry cells will also serve the purpose and since they are larger, they will last longer.

The second type of battery required is known as a B battery. Its purpose is to keep the plate of the tube at a certain definite potential (voltage). The 30 tube will operate very satisfactorily using a compact 22½ volt B battery. When the filament is heated by the two A cells in series and the proper B voltage is supplied to the plate, the tube is then ready to function.

Its action is based upon the passage or flow of minute electrical particles within the tube between the grid and the plate. The tube, when functioning thus, is said to be conducting, and the current is d.c. The tube is somewhat similar to a one-way valve, since it permits passage of an electrical current in one direction only and prevents it in reverse.

How Detection Takes Place

In this way the high frequency alternating (rapidly reversing) current induced in the antenna is eliminated, only slow pulses, called pulsating direct current, remains, and this is of the same variation as the program. Hence the residual current energizes the electro-magnets in an earphone so as to produce audible sounds.

In some far-off land, a radio program is broadcast by means of a transmitter which sends out electromagnetic waves. These travel in ever-widening circles at the velocity of light, 186,000 miles a second, to the far ends of the earth. As these waves cut across your antenna, they set up minute electrical currents which must be rectified, as outlined above, before they can be made audible. Your receiver must also be tuned or adjusted to the wavelength of the transmitting station. This is accomplished in the writer's all wave kit by a single variable condenser of such value that it can efficiently and completely cover the entire range of from 10 to 550 meters when used in conjunction with five separate plug-in coils.

These coils plug into a socket just like a tube and can be changed readily whenever one desires to receive on a different high frequency band.

What to Select

For example, to receive foreign stations, the 20 to 40 meter coil or the 40 to 80 meter coil is plugged in. To receive amateur conversations, one uses either the 40 to 80 meter coil or the 70 to 200 meter coil. For standard broadcast entertainment, the 200 to 550 meter coil is employed. Thus, it is possible to receive on a different band by changing the plugin coil.

magnetically with the secondary in which the incoming carrier is predominant. This extra winding, thus connected, steps up or increases the intensity of the receiver, thus increasing sensitivity and range a thousand fold. This effect is called regeneration. A suitable rheostat or potentiometer in the plate circuit of the tube permits one to control the degree of regeneration at will between certain minimum and maximum limits.

Two More Tubes for Speaker

Two other controls are also provided in this set. One is the antenna trimmer which consists

One tube receiver designed by the author, with which he tunes in foreign stations on one tube. Batteries are used, also plugin coils.

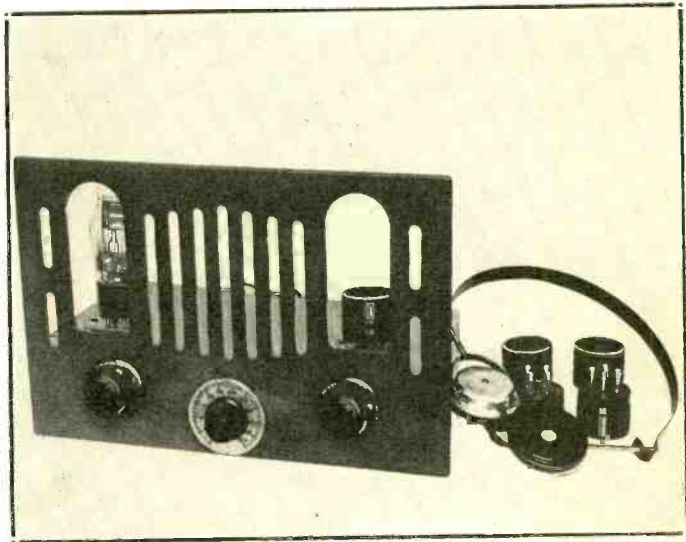

Police calls can be brought in from all over the United States.

There are many other exciting and interesting forms of short wave reception. Naturally, foreign program reception holds the greatest popular interest. In addition, there are human-interest transatlantic phone conversations, weather and news reports, talks between airplanes and airports, amateurs conversing over great distances, code signals both amateur and commercial, radio beacons, etc.

Getting back to our all wave kit, we have shown how the heart of the kit, the tube, is energized by "A" and "B" batteries; how the signals are picked up by the antenna; and how the set is tuned to the desired wave length. The desired wave, when tuned in, is impressed on the grid of the tube, is rectified (changed from alternating current to pulsating direct current) and these remaining audio frequency equivalents are fed into headphone which render audibility.

Regeneration's Effect

Of course, the actual kit contains several important refinements in addition to the fundamentals outlined above. For instance, there is an extra winding on each plugin coil, called a "tickler" winding. This is connected electrically in the plate circuit of the tube and coupled

of a low capacity variable condenser in the antenna circuit. Adjustment of this condenser permits separation of crowded stations on the broadcast band and also helps the tuning in of foreign stations. The other control consists of a 40 ohm variable resistor in the fila-circuit. As the A battery becomes weaker, more and more of this resistance is cut out of the circuit, thus making it possible to maintain a constant voltage of correct value on the filament of the tube.

If loudspeaker operation is desired on all stations, it is a simple matter to add two audio stages, using a second 30 tube and a 33 output tube. Plenty of room should be provided on the chassis base for this purpose and it will be noted that the panel has a grille especially for the purpose of mounting a speaker.

FRANK GRIMES WITH HARRISON

Frank Grimes has become associated with Harrison Radio Company, 12 West Broadway, N. Y. City. He was manager of Wireless Egert years ago. He takes care of technical information on and sales of receivers, transmitters, diathermy, or special equipment.

The Favorite Receiver of Home Constructors: 5 Tube T.R.F.

By Jack Goldstein

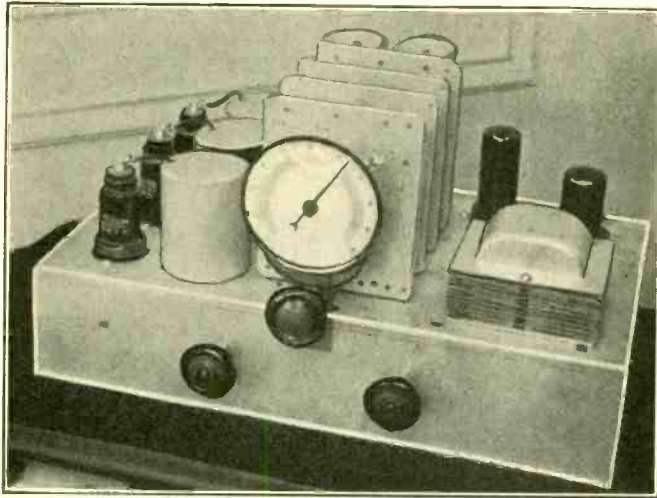

The volume control at left governs the bias on the two radio frequency amplifier tubes. The knob at right is for the time control which has the a.c. switch attached.

THERE is no doubt that home constructors favor the standard broadcast band tuned radio frequency set against the superheterodyne, perhaps because it is easier to build, requires only a simple adjustment, and therefore is more likely to give results measuring up to expectations, even when the construction is done by a novice. Also, the most popular arrangement is one requiring five tubes, so that there are two stages of tuned radio frequency amplification, tuned input to the detector, and a resistance coupled audio stage leading to the pentode output tube. The fifth tube is the rectifier.

The five tube t. r. f. set for a. c. operation is almost standard, and that means it has stood the test of time, and the "bugs" are removed from it. In the present instance all-metal tubes were used throughout, the 6K7 in the r. f. positions, the 6J7 as detector, the 6F6 as power tube and the 5Z4 as rectifier.

Band Is Fully Covered

The detector has been provided with an overload governor that prevents the detector grid from becoming positive biased on strong locals or during energetic passages of musical rendition. Also, provision for connecting a

phonograph pickup, and changing the detector to an amplifier, adds another service, with abundance of volume from phonograph reproduction. The pickup circuit is better suited to the high impedance type instrument.

With such a circuit bountiful results are obtained on the standard broadcast band, which is fully covered, the lowest broadcast frequency being tuned in, and in fact at the other end some police calls and amateurs.

Let us take up the circuit, tube by tube, discuss what the components are and what takes place, and then proceed to the wiring.

There are three coils of similar construction, consisting of high impedance primaries, with very small capacity coupling to the secondaries. This capacity consists of the condenser effect between a turn of wire brought up from the primary and wound around the secondary, one end of this single turn open. The primary is not inductively coupled to the secondary, and the capacity that produces the coupling is of the order of 10 mmfd.

Establishing Selectivity

So the antenna is connected to one side of the high impedance primary, other side of pri-

(Continued on page 36)

LIST OF PARTS

- Two .1 mfd., 400 volts.
- One .5 mfd., 200 volts.
- Block of two .05 mfd., 200 volts.
- One .05 mfd., 200 volts.
- Two 8 mfd. Cornell-Dubilier electrolytic condensers in separate cylindrical aluminum containers, 450 volts, continuous working, d.c.
- One capacity tone control (Filterette); a.c. switch attached.

Resistors

- One 150 ohm.
- One 500 ohm, 1 watt.
- Two 25,000 ohm, 1 watt.
- One .025 25,000 ohm and one 5,000 ohm.
- One .5 meg., 1 watt.
- One 10,000 ohm potentiometer.

Condensers

- One three gang .00035 mfd. tuning, with trimmers.
- One .02 mfd., 400 v.
- One .006 mfd., 400 volts.
- Two .1 mfd., 200 volts.

[Unspecified wattage means anything is suitable from 1/4-watt up.]

Other Requirements

- Chassis, 13 3/4 x 8 x 3 inches.
- One dial, escutcheon
- One ft. 3/8" diam. shielded wire.
- Three knobs.
- One standoff insulator (two insulated lugs).
- Three miniature grid clips.
- One a.c. plug and cord.
- Antenna-Ground posts.
- Switch for bias change (needed only if phono pickup is used).
- Twin assembly jack for phono pickup.
- Five octal sockets and one five-hole socket (for speaker).

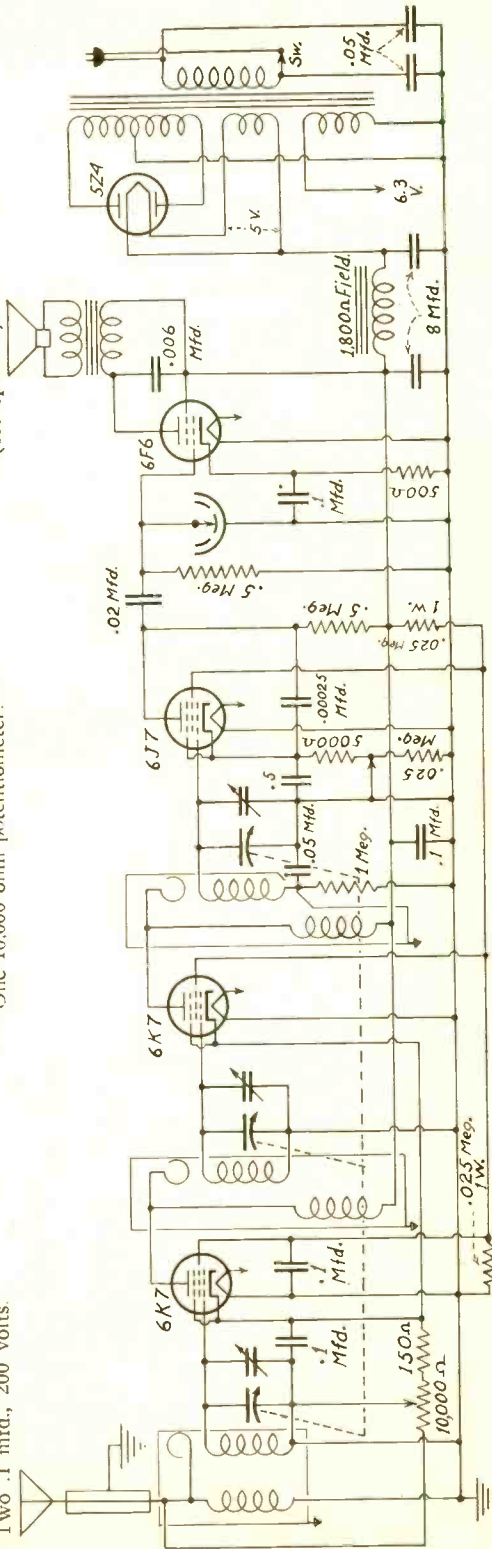

The wire from set antenna post to antenna connection on the switch and putting pickup in series with the .05 mfd. to ground. coil is shielded, of 3/8 inch outside diameter. Thinly stuffed shielded See blueprint. If 6.3 volt winding is not center tapped, use as wire causes too great a loss to ground through capacity. The above, otherwise as in blueprint. The tone control is the three-phonograph connection is to be made by closing the 6J7 bias capacity device to left of 6F6.

FIVE METAL TUBES IN

BLUEPRINT of the metal tube tuned radio frequency set, showing wiring on under side of the chassis. All connections are shown, except the actual ones to stators of the three section tuning condenser, and the leads from G of the coils

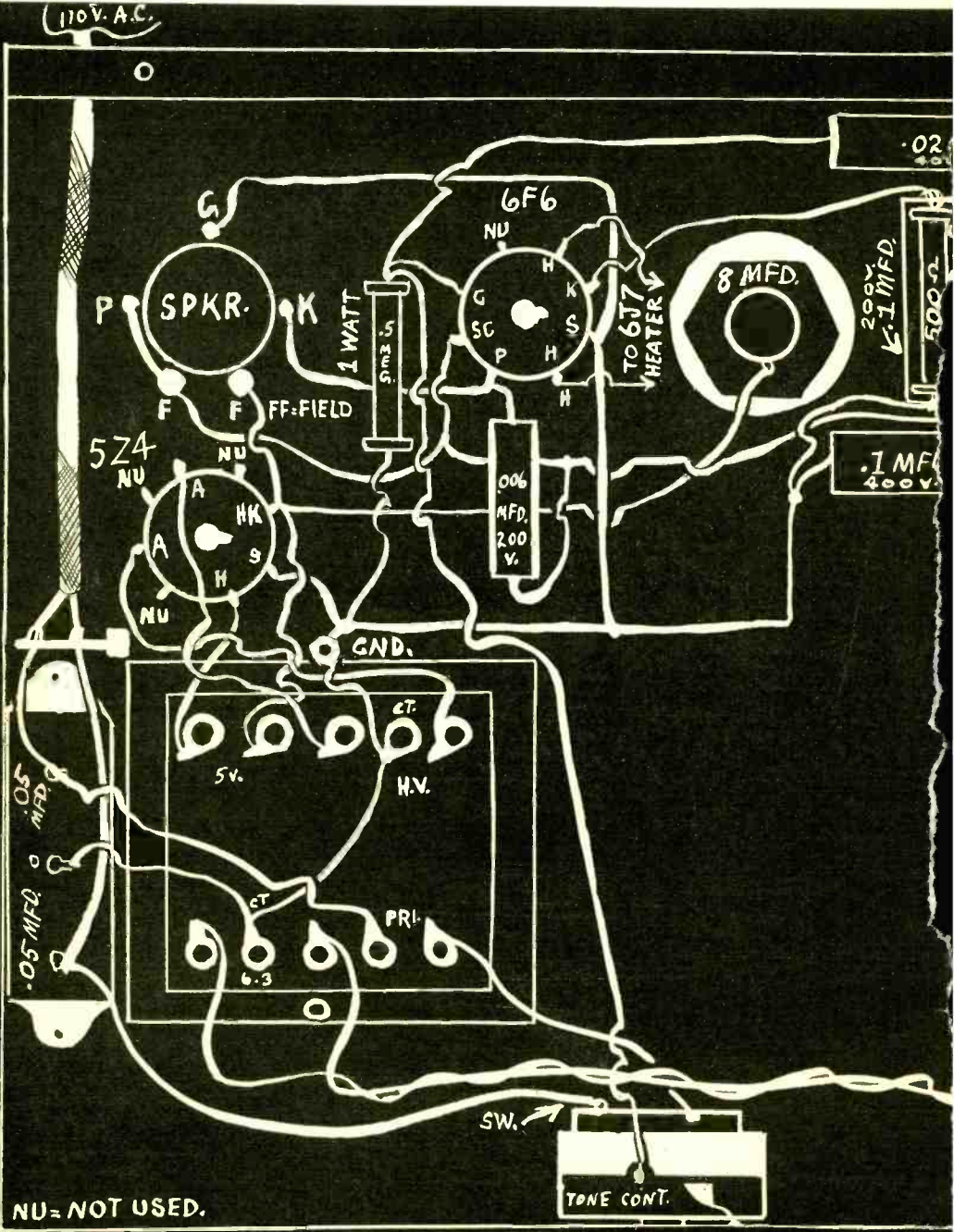

FAVORITE T.R.F. SET

o overhead grid caps of the three tubes | caps of these tubes. The sheath of the
 t right. Leads emerge through the coil | shielded antenna-to-coil wire is also used
 hields from G of coils for connection to | for the grounding of some resistors.

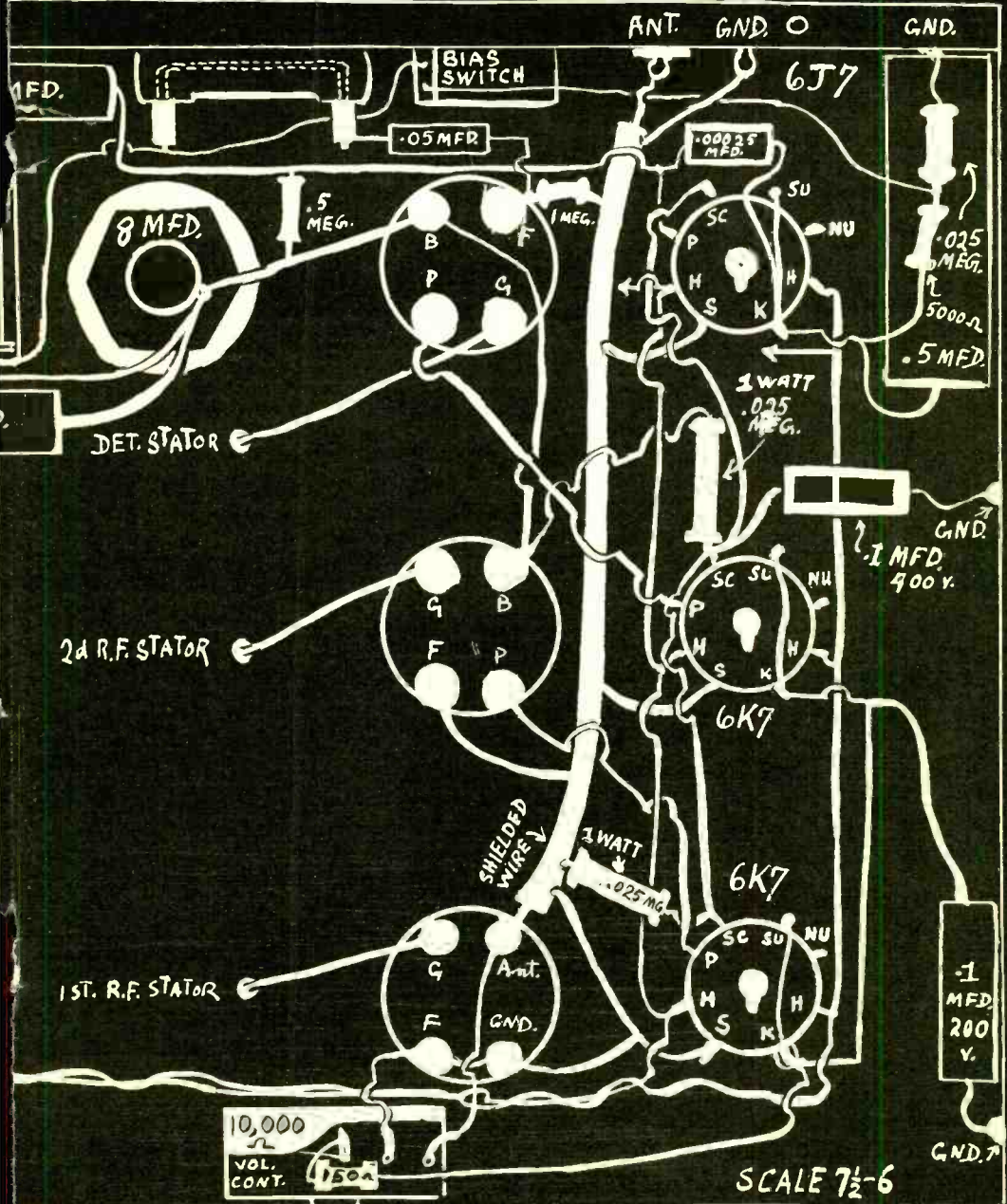

(Continued from page 32)

mary to ground. As there is no inductive coupling, and only the tiniest capacity between primary and secondary, there would be no transfer of antenna energy, so the coupling turn is used. Commercial coils usually have four lugs or leads at bottom, connection to the one of which taking care of both primary branches because of a lead made common within the coil.

The station waves are of all frequencies, in the antenna, which is therefore indiscriminately excited, and it becomes necessary to use some discrimination. This is done by tuning, which is the setting up of a circuit that finds one frequency more acceptable than any other. So if we have enough tuned circuits we pile up the discriminating effect to the extent that we have practical selectivity, as we do in this set.

Across the secondary is put one section of the three gang tuning condenser. So far we have tuned, but to no purpose, so we have not put the selectivity to any use.

How the Bias Arises

This use is accomplished with a vacuum tube, the first 6K7, at left, and between its Grid No. 1, or control grid as it is called, and the B minus leg, which is grounded, we put the secondary. Now, if the cathode, or electron emitting element of the tube has a resistor interposed between itself and B minus, any plate voltage that is applied will produce a current that must seek its way back, to complete the circuit, through the cathode to B minus. The plate current passing through a resistor makes the cathode positive in respect to the other end of the resistor, or makes the "other end" minus in respect to cathode, both being expressions of the same fact. With grid returned through the continuous winding of the coil to B minus, the grid is negatively biased.

Now, a fixed resistor could be used, indeed one is used, but in series with it is an adjustable resistor, a potentiometer of 10,000 ohms. The circuit consists of the following sequence: cathode, fixed resistor of 150 ohms, potentiometer of 10,000 ohms maximum, antenna, high impedance primary of antenna coil, and ground. Since B minus is grounded, the cathode to B minus circuit is completed, although in a round-about way, so let us inquire into the reason for the indirection.

Bias Volume Control

First, let us assume that the adjustable resistor were returned directly to B minus. That would be all right. The adjustment of this resistor still would change the bias on the tube, making it more negative as more resistance was introduced, because the voltage drop across the biasing resistance branch would be increased, and we would have a volume control. But it would be a certain kind of a volume control. What kind?

A tube is a device the resistance of which is varied to produce desired results. The variation now in mind is that of the plate resistance for the purpose of reducing the amplification.

Suppose a very strong station were being received and we turned the volume control down low, we would be reducing the amplification and hence the volume, but we would be leaving the input level intact. That is, the antenna is putting just as much into the secondary, hence grid circuit, as before, and no volume control adjustment would alter the amount of that input.

It has been found that persons living in cities sometimes hear a strong local when they tune to a weaker local not far removed from the other in frequency, say 50 kc. In fact, the strong local comes in at different dial positions, represented by the frequencies of other stations, including distant ones, that should be heard alone but are drowned out. This is called cross-modulation.

Reducing Quantity of Input

Obviously, if cross modulation is due to putting into a tube more signal voltage than it will stand, the corrective is to reduce the amount of input. That is why the potentiometer is connected as shown, through the primary to ground, instead of directly to ground, because as the slider is moved down the antenna is brought nearer to ground potential, and finally there is a complete short circuit of input. And as the amplification is reduced also when the slider is moved down, because of increased negative bias, both objectives are attained together. The potentiometer is used as a rheostat.

The first tube's circuit is completed by connecting the third grid (screen) to a B voltage lower than maximum B, and by connecting Grid No. 3 (suppressor) to the cathode.

Across the circuit consisting of B plus maximum to B minus we put two 25,000 ohm resistors, so that when screen is connected to the joint the proper B voltage will be applied to the screen. This same voltage serves for three tubes.

To get something out of the first tube we have to put a load on the plate circuit. Thus the primary is connected between plate and maximum B plus, and the amplified and selected carrier develops across this winding a voltage maximum its own frequency, and this is put into the secondary in the same capacity coupled manner as before. By repeating the tuning in the next circuit, input to the second 6K7, we increase the selectivity. And when once again we repeat the process, and feed the 6J7 detector, we attain a degree of selectivity of practical value.

The Automatic Overload Preventive

Besides selectivity having been increased, the carrier voltage has been amplified greatly, so that we have enough for substantial detector output, and with the amplification in the power stage enough to work the speaker. However, the detector does not stand a strong signal, either, because its detector bias should be only a few volts for best sensitivity and tonal results. Again to prevent overshooting the mark under circumstances when no manual control could

be operated quickly enough, we check detector overload automatically with a resistor having a condenser across it, put in series with the secondary of that feeds the detector. When the carrier amplitude or intensity at the detector input is greater in peak volts of a. c. than the d. c. bias on the grid, since the two work in the opposite direction, the detector grid becomes positive and direct current flows, due to grid rectification. In point of fact, the detector grid does not have to be voltaged by carrier as high as or higher than the d. c. bias, but grid current flows, or the tube serves as a rectifier in an unintended branch, when the effective bias (peak signal amplitude subtracted from d. c. bias) is .8 volt negative.

However, we may consider the circumstances more simply by saying that strong signals make the detector grid positive, so that direct current flows in the grid circuit, which is thus also an additional rectifier. These strong signals are usually unexpected. They may result from random tuning and picking up a strong local with volume control all the way up, or may arise beyond one's manual control, due to momentary failure of proper monitoring at a studio (as when a speaker following an orchestra is for a short while made to sound as loud as the orchestra), or may be due to tempestuous passages in orchestral music.

How the Overload Governor Works

Whenever the grid becomes positive the corrective is automatically applied, because the direct current flowing through the circuit is made to pass through a high resistance, and the very nature of a rectifier is such that the cathode is positive to d. c., hence the anode (here the grid) is negative to d. c. So that the negative value, produced during only half the cycle, that is, during the positive alternation, shall become a steady average value, the condenser is included across the resistor. During the positive cycle the condenser is charging from the voltage across the resistor and during the negative cycle the condenser is discharging through the resistor. So we have a continuous effect and mean value of negative bias. The stronger the signal, the more negative the bias, hence overloading is corrected.

Hence for very strong signals automatic volume control is introduced. In general it may be stated that the a. v. c. is applied to the detector tube as a bias voltage, delayed by the amount of the self bias through the cathode leg resistor. The delay simply means that not until the conventional bias is overcome almost completely by the signal does the extra bias arise to assist the other.

Detector Bias Changed

The circuit is so arranged that the resistor is always continuous, but the condenser is connected to a pair of posts. For phonograph pickup connection connect pickup to the posts. For other use put a shorting wire across the posts. Also, to get real gain from the 6J7 for phonograph service, the tube is made strictly an amplifier by lowering the bias. A switch at

rear takes care of this, by reducing the biasing resistance to 5,000 ohms from a total of 30,000 ohms.

The elimination of the radio frequency carrier takes place in the plate circuit of the 6J7, the alternating current is wiped out, the fixed condenser being put from plate to cathode to aid this elimination. Rectification resolves all the current into direct current, but pulsations are present, due to and equal to the modulation, which is the only component of the carrier that has been retained. It has not been retained at the radio frequency level but at the original sound level, as the electrical counterpart of sound frequencies.

The Final Tube

The d. c. pulsating at audio frequencies develops a potential difference across the detector plate load resistor, a stopping condenser is used for isolating the high d. c. potential of the detector plate from the low d. c. potential of the power tube grid, and at the same time be large enough in capacity to enable adequate discharge of currents the lower audio frequencies, and so we have input to the final tube, across the grid leak of which the pulsations appear as alternating current again, due to the stopping condenser's discharge. The speaker is connected to the final tube's output.

A field coil is present in the dynamic speaker, and must be excited with d. c., so to economize we pass through it the total B current of the set and therefore have the field in service as B choke. Filter condensers complete the hum elimination.

The fifth or rectifier tube changes the line a. c. to pulsating d. c. values, and the filter just discussed eliminates the ripple.

Board Approves Trial of Television Cable

Washington.

Approval of the petition to construct a coaxial cable between New York City and Philadelphia was given by the Federal Communications Commission. Construction was to be begun by New York Bell Telephone Company and the American Telephone and Telegraph Company by July 1. The cable will handle television, modulation frequencies, passing a band width of 1,000,000 cycles without attenuation.

High frequency carriers, therefore, bearing television modulation, need not cause the television service area to be limited to the horizon distance, since the modulation could be sent over a coaxial cable at far greater distances, and then used as modulation on individual high frequency carriers along the way. This would lift television's restriction from local area service to the possibilities of national coverage, with a single studio of origin.

Bell Telephone is not interested in television from any save a traffic viewpoint, but R.C.A., Philco and Farnsworth are, and all three have plants in and about Philadelphia. The new cable is to be open to all.

New Tuning Indicator Tube

6G5 Has Cutoff at Minus 22 Volts

By W. M. Perkins

Chief Engineer, National Union Radio Corporation Laboratories

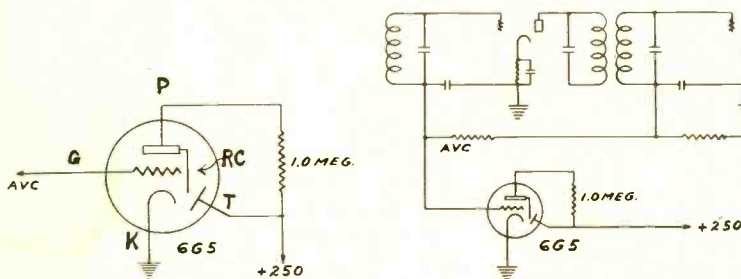

FIG. 1

The elements of the 6G5 are: G = grid, P = plate, RC = ray control electrode, T = target and K = cathode.

FIG. 2

Typical basic circuit of the intermediate frequency amplifier of a superheterodyne, with last tube (at right) a diode. The a.v.c. voltage is applied to 6G5's G to K circuit. Full a.v.c. is shown, assuming rectified component does not exceed 22 volts.

THE cathode ray tuning indicators now in vogue are interesting both in principle of operation and results obtainable from same. A general understanding of the principle of operation may be gained by thinking in terms of an analogy. Omitting, for the moment, consideration of the triode unit, the cathode ray unit may be viewed in the light of an optical analogy. In such an analogy, the cathode becomes the source of light, and the target becomes a screen on which the light shines. Interposition of an opaque member between the light source and the screen will produce a shadow, and changes in size of this opaque member will produce changes in size of the shadow.

In the cathode ray tuning indicator unit we have an electronic setup closely analogous to the optical setup just mentioned. A thin metallic member (the ray control electrode) is interposed between the cathode and the target. Variations of voltage on this member with respect to the target have, electronically, the effect of changing its size, and consequently, the size of the shadow on the target.

This is true because changes of intensity of the negative field around the ray control electrode repel electrons in proportion to the strength of the field, and the extent of this repulsion determines the width of the shadow area.

Works Like a Pivoted Member

The relation of the shadow size to the voltage of the ray control member may be kept in mind by thinking of the member as a thin, bladelike structure, pivoted, so that when it is appreciably more negative than the target, it

turns in such a position as to present its greatest area to the light source (the cathode), and thus, produce the largest shadow on the target. Then, if its voltage is varied in the direction where it approaches the same voltage as that of the target, the member effectively rotates so as to present its thinnest edge to the light source, and thus a smaller shadow is produced on the target. Of course, in a cathode ray unit, there is no mechanical movement, although the action produced is as if there were.

Variations in voltage of the ray control electrode are produced by means of the triode incorporated in the cathode ray tuning indicator. The ray control electrode is connected directly to the triode plate, and this triode functions as a d.c. voltage amplifier. Fig. 1 discloses that the triode plate returns through a one megohm resistance to the voltage source applied to the target. Changes in current through this one megohm make the triode plate, and consequently, the ray control electrode, vary in voltage with respect to the target in strict accordance with the current changes. The current change desired is produced by virtue of the mutual conductance of the triode when the voltage of the triode control grid is altered.

Curve for Tube Voltmeter

In effect, the arrangement shown in Fig. 1 is a vacuum tube voltmeter, which translates the voltage changes, applied to the triode grid, into corresponding changes in shadow angle on the target. The approximate calibration curve of such a setup, viewed as a vacuum tube voltmeter, is given in Fig. 3. For tuning indi-

ator purposes, this vacuum tube voltmeter setup is used to indicate the changes of the a.v.c. voltage produced in a receiver when same is tuned.

The actual application of the cathode ray tuning indicator to a receiver having automatic volume control is simple. Fig. 2 shows the circuit arrangement of the a.v.c. portion of the customary superheterodyne. It will be noted that the triode grid of the tuning indicator tube is connected to the a.v.c. voltage. As the actual value of the maximum a.v.c. voltage developed in a receiver is a function of many factors, such as the strength of the broadcast station, the number of tubes under control, etc., no positive statement can be made as to the maximum a.v.c. voltage to be expected. However, under normal conditions, with two tubes under control, an a.v.c. voltage up to approximately minus 22 volts may be expected on very strong stations.

The first cathode ray tuning indicator tube to make its appearance, type 6E5, incorporated a triode, the control grid of which could handle up to minus 8 volts bias. Consequently a voltage divider network was necessary across the a.v.c voltage source, to reduce the voltage applied to the 6E5 grid.

Curve Extended to Minus 22 Volts

The relation between the 6E5 control grid voltage and the shadow angle is approximately linear, and so, with the proper a.v.c voltage divider network, the shadow angle change of the

6E5 is small on weak signals, if properly adjusted, to prevent overload on strong signals. The term "overload" here meaning complete closing of the shadow angle before a strong signal is properly tuned.

The inclusion of a triode unit, having a variable mu characteristic, in the cathode ray tuning indicator permits of the application of a.v.c voltage to produce appreciable movement of the shadow on weak signals, and still prevent overload on strong signals. The type 6G5 cathode ray tuning indicator, just announced by the National Union Radio Corporation, is of this type. Fig. 3 gives the control grid-shadow angle characteristic for the new 6G5. The tube is capable of handling approximately 22 volts bias directly on its control grid, and so, in many instances, it is feasible to connect the control grid directly to the a.v.c voltage without the necessity of a voltage divider network.

Variation of Angle

The type 6G5 is a tube designed to be used as a visual tuning indicator. In use, the end of the tube appears as a luminous disk with a sector cut out. The angle of the sector varies from 0° to 90°, depending upon the applied voltages, and it is this varying angle which indicates tuning when properly connected into a radio set using a.v.c. The sensitivity varies with the applied voltage in such a way as to make the operation of the 6G5 effectively more

(Continued on next page)

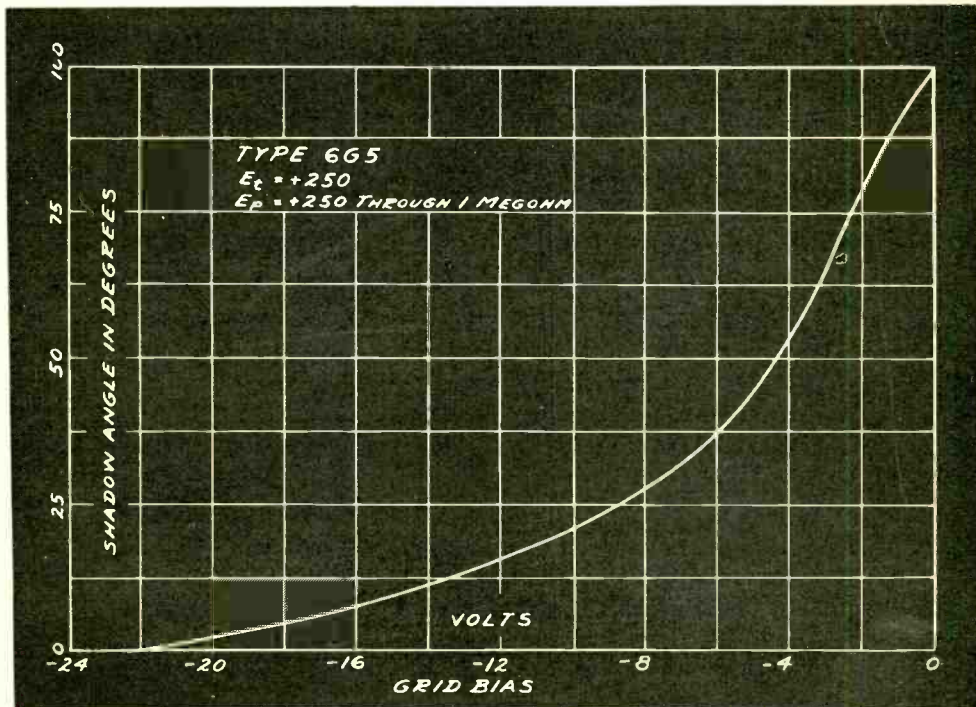

FIG. 3
D.c. grid bias plotted against shadow angle in degrees.

(Continued from preceding page)

sensitive to weak signals. In this way, a larger range of signals will be tunable by vision for a given set of conditions.

MECHANICAL DATA

Maximum Overall Length— $4\frac{1}{4}$ inches.
 Maximum Diameter— $1\frac{9}{16}$ inches.
 Bulb—ST-12.
 Base—Small 6-pin.
 Pin No. 1—Heater Pin No. 4—Target.
 Pin No. 2—Plate Pin No. 5—Cathode.
 Pin No. 3—Grid Pin No. 6—Heater.

ELECTRICAL DATA

Heater Voltage (a. c. or d. c.)—6.3 v.
 Heater Current—0.3 amp.
 Plate Supply—250 max. v.
 Target Voltage—250 max. v.
 Series Triode Plate Resistor—1 megohm.
 Triode Plate Current for Grid Voltage = 0—0.25 m. a.
 Triode Grid Voltage to give 0° Shadow— -22 approx. v.
 Triode Grid Voltage to give 90° Shadow—0 approx. v.

What the Target Is

The target of the 6G5 is a shallow, cup-shaped electrode placed in the dome of the bulb, surrounding one end of the cathode. Between the cathode and the target is a control electrode which functions to block the passage of electrons near it, thereby causing a blank area on the target in the shape of a sector. The range of voltage required by the control electrode to open from 0° to 90° is approximately 70% of the target voltage, thus necessitating an amplifier to make it applicable as a

tuning indicator. To this end an amplifier tube of the triode type is enclosed in the same envelope.

The control electrode is directly connected internally to the plate of the triode. When a one megohm resistor is connected between the plate and the target terminals, the overall sensitivity of the indicator is such that zero volts on the triode grid results in a 90° shadow, while with approximately negative 22 volts the shadow is reduced to a thin line.

In radio receivers where more than negative 22 volts is supplied by the a.v.c. to the grids of the tubes under control, division of the a.v.c. voltage is advisable before applying it to the 6G5.

Should Act Sufficiently Fast

Care must be taken to eliminate practically all the audio modulation component from the voltage applied to the grid of the 6G5, otherwise the edges of the dark sector on the target will blur out on modulation peaks. On the other hand, care must be taken not to have too much lag between the a.v.c. source and the grid of the 6G5 as would be brought about by using a resistance-condenser audio filter with a very large time constant, since this would make the 6G5 response quite sluggish.

The shadow opens symmetrically on each side of the line where it just closes. This line is approximately parallel with a line passing through Pin 2 and Pin 5, and is on the same side of the tube as Pin 5. This is held to within 10 degrees. Where such a variation in position of the sector cannot be tolerated, some means of orientating the socket should be provided. The maximum diameter of the dome of the bulb is $1\frac{3}{16}$ inches.

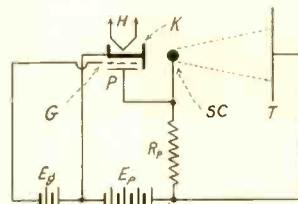
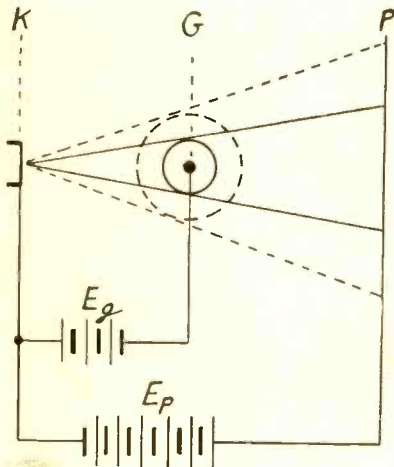

These illustrate the principle of the ray indicating tube. At left K is the cathode, or source of electrons, P the positive target, and G is a small obstruction impervious to electrons. The greater the negative bias on G the greater is the effective size of the obstruction and hence the larger the shadow cast. At right is shown the tube preceded by a resistance coupled amplifier, which is an integral part of the tube. The voltage on the control element SC is varied by the signal drop in R_p .

22 VOLTS NEGATIVE TO MAKE THIN LINE

Positive D.C. or A.C. Input to Ray Tube

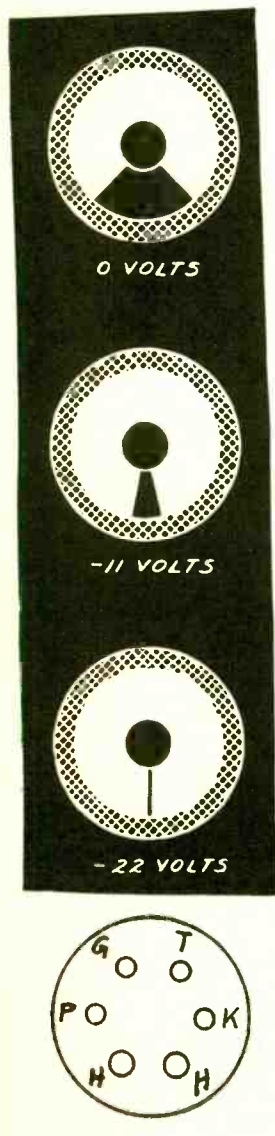

THE ray indicator tube is most commonly used with a negative voltage applied to it from a diode detector. That is practically the only convenient way of obtaining a negative potential that varies with the carrier or signal. The other available variations are in a positive direction, in the sense that the positive alternation causes a considerably larger change in plate current than does the negative alternation, hence the effect is to introduce a rise in plate current, as if only a positive voltage were applied to any tube in the set.

If it is desired to use a ray indicator tube so that positive values will produce an effect, like that the negative values do, the triode should be negatively biased to produce the thin line. Then when the ray indicator is not excited the thin line prevails, whereas application of unknown voltages, if d.c., must be positive, and now for the first time a.c. will register. Otherwise a.c. would not produce a satisfactory deflection.

The bias method just mentioned therefore reverses the light angle, which in normal practice is widest, about 90 degrees at no input, and now becomes a thin line at no input, widest angle at maximum allowable input. Also the 90 degree angle, as well as the smaller angles, down to the "thin line," are angles of light and not of shadow. That is, the angles shown as black are really the light ones.

Antenna Condenser Helps

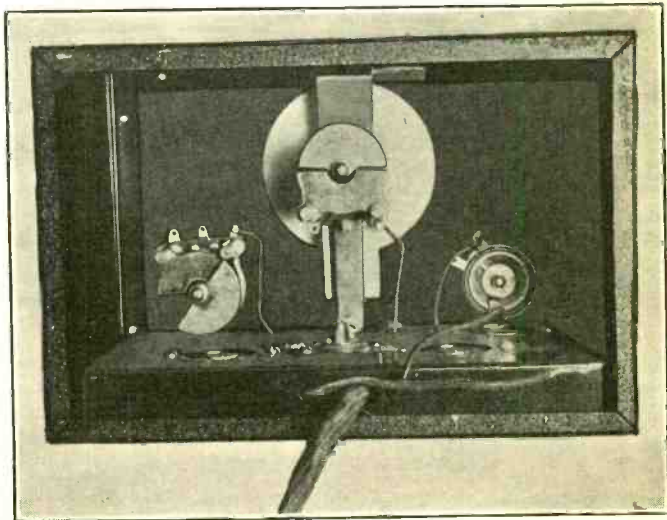

FIG. 4
Change in shadow angle illustrated. Bottom view of the socket is shown also.

A small variable condenser (left) in series with the antenna enables adjustment of the electrical length of the antenna, so that the antenna is matched to the frequency or wavelength of each short-wave station. This is wave resonance. Regeneration may be controlled by rheostat (right).

Testing Vacuum Tubes

Methods Analyzed and Compared

By Vincent R. Meehan

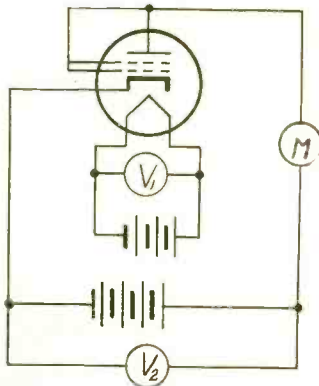

Emission test. The voltage V_1 is as prescribed in charts. V_2 is optional, always higher than V_1 .

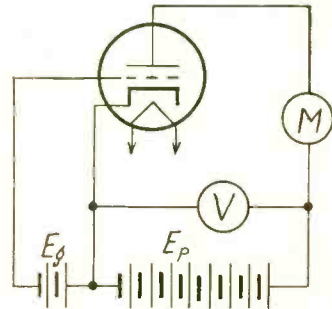

Plate resistance test by the static method. $R = dE_p/dI_p$ Instead of d the symbol Δ is often used.

THE vacuum tube serves as a rectifier, that is, changes alternating current to direct current; it acts as an amplifier; it supplies power as needed.

The rectification property is the same as found in changing a modulated carrier frequency to audio frequencies of pulsating direct current. Detection and rectification are the same in principle. The mixer tube in a superheterodyne is also a detector, sometimes called the first detector, although more recently simply the word detector has been reserved for the second detector, and the other or first detector is called the mixer or the converter tube. Any changing from one frequency to another or wiping out part of a wave is detection.

As an amplifier the tube receives a smaller voltage and delivers a larger voltage. As a supply of power for radio and audio frequencies, it enables the development of enough energy in the plate circuit to perform a certain work, say, to radiate power from an antenna, as in transmission, or to drive a speaker, as in a receiver.

No Single Test Perfect

When a vacuum tube is to be used, naturally it is prudent to test it, lest there be something wrong with it that could do injury if the tube were inserted otherwise untried in a receiver. There is no single test of a vacuum tube that will give an inclusive report on its condition, so one must compromise.

The simplest way to give a tube a good single test is to use an emission tester. The

emission refers to the electrons given off by the cathode and indeed the cathode is defined as the electron emitter. Thus if the other functional elements are tied together to constitute one single element electrically, and the cathode is maintained separate, a direct voltage introduced in proper polarity between cathode and unified anode will show the emission from the cathode. For stated conditions this emission should be so much—differing with types of tubes—and as the tube ceases to be as good as the average standard, the emission drops.

It is not possible with the emission test to determine definitely whether the tube is any good, since the test may show the tube to be fine, although the tube is worthless; or the test may show the tube to be worthless, whereas the tube is serviceable.

Serves a Purpose

On this statement of fact many might shrink from the idea of having an emission tube tester, yet most testers in use are of that type, and they serve a purpose, consistent with economy and fairness of results.

The exceptions, when the emission tester does not give the true story, are not numerous. They include reporting tubes as excellent when the cathode is dead, except for an overactive area so far removed from grid to render the tube useless; also the report of "bad" on some types of tubes because emission is low, although this type functions very well in a set at emission greatly reduced from the original value.

The emission test is called a static test be-

cause made with d.c. There isn't any static test of a vacuum tube that actually reports the service of a tube in a receiver, and in the doubtful cases that arise with many types of tube checkers it is always pertinent to insert the tube in a receiver, in the socket in which it is intended to function, and compare the set output against a tube of known excellence in the same position.

Emission Testers Plentiful

In this way, in fact, signal generators are sometimes used in conjunction with receivers and transmitters, to check the performance of tubes.

The emission tester is the most numerous type of checker, and will be found on counters in stores, as well as on service benches throughout the world, and performs a recognized service.

A mutual conductance tester is considered superior to an emission tester, because when the mutual conductance of the tube is determined, one has in general the basic figure of merit of the tube.

The mutual conductance test may be made dynamically to better advantage than statically. We may take the word static in these tube considerations to refer to d.c. tests and dynamic to a.c. tests. Therefore the dynamic mutual conductance test tends to disclose the manner in which the tube will perform under actually operating conditions in a receiver, where a.c. inputs are utilized almost invariably.

Power Output Test Preferred

Certainly the emission tester or the mutual conductance tester of either static or dynamic characteristics, does not spell perfection; neither does any other single test tube checker, although the one that comes nearest to the goal is the power output tester. There are two types of output, Class A and Class B, as the type that lies between may be tested as Class A. In either instance the grid voltage input is a.c. In Class B the output voltage is a.c. also. In the Class C test a sufficiently close report on the tube's condition is obtained when d.c. is used as the output measurement, i.e. plate current through d.c. meter is read.

This tube checking unitary method best reflects the tube performance that will take place in a receiver, because the amplification of the tube and the amount of voltage obtained at the output are determined. These are basic for voltage amplifiers. The only other type of amplifiers are power amplifiers, where the checking is more intimate, since the a.c. is read, and the load resistance is known, therefore the power output is directly computable.

Closer to Precision

Thus the test unites in one operation the two basic requirements, to determine how good a tube is and for the type of service for which it is intended. The emission tester does not differentiate between the service type at all, neither does the mutual conductance test of either type, and the closer one gets to the reflection of the actual receiver condition, in

checking the tube, the more reliable the results of the test.

The methods outlined all have to do in general with a single test. That is, whatever the tube, it is given one test, although in the power output tester this is the particular type of test most applicable to the tube.

Multiple Testing

However, it is practical, with little extension of apparatus, to make multiple tests. One may solve for the principal characteristics of vacuum tubes, which are the amplification factor, the plate resistance, the mutual conductance and the conversion conductance. The amplification factor is the gain produced in the tube alone,

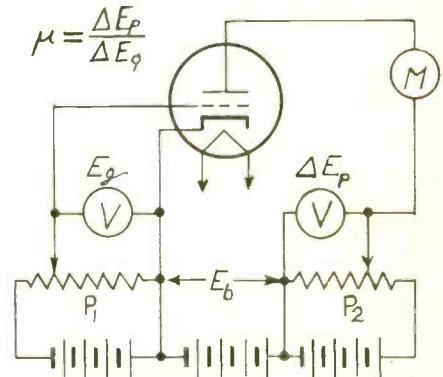

Amplification factor determined by the d.c. method. The answer is obtained by dividing a small difference in plate voltage by the difference in grid voltage necessary to restore the plate current to where it was at first. The triangle, delta, is the symbol for difference.

though this is less than the practical circuit gain. The plate resistance meant is always the a.c. resistance, never the d.c. resistance, and equals the opposition to a.c. flow offered by the plate to cathode circuit. The mutual conductance like the others is a ratio, this time the ratio, a change in plate current divided by the change in plate voltage, grid voltage constant. The conversion conductance is likewise a ratio, that between the intermediate frequency in the plate circuit of the mixer tube, and the voltage of the carrier level frequency put into that tube to help produce the i.f.

If one likes, therefore, he may check tubes, not only for their power output, but may use the individualized tests, and thus have a dissected view of the tube performance, and if any trouble exists, locate it precisely. Also, tube matching becomes easier by the individualized test, as where tubes of equal characteristics are desired for push pull stages.

Static Versus Dynamic

It would be well, however, to inspect more
(Continued on next page)

(Continued from preceding page)

closely the definitions of the four factors, as we find that the definitions will have to do with the use of d.c. for tests, and d.c. tests are by our previous definition static, while the preferred tests are dynamic.

The first fact to bear in mind is that the changes that are to be recommended are small changes, indeed very small changes, and therefore the definitions acquire significance. Tube curves are not straight, with few exceptions. Allowance for the curvature, or the displacement of current unequal to a displacement of voltage, makes the dynamic tests more accept-

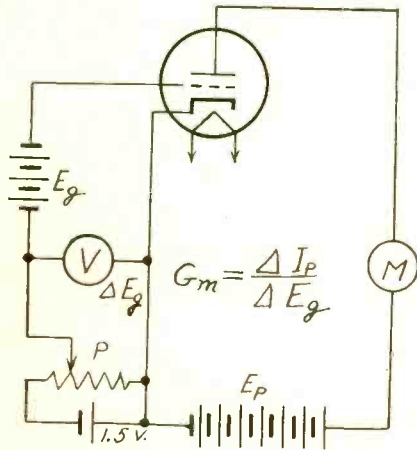

Mutual conductance by the static method. It is equal to the difference in plate current divided by the difference in grid voltage—both values small—when the plate current is held constant.

able. And yet the definitions are for d.c. tests, save for conversion conductance. However, if the changes to be considered are very small in fact, then the results of either static or dynamic test will not be far apart, for very small, one might say, tiny changes, are linear so far as we can measure them, and while the definitions are based on a theoretical change infinitely small, we mar the picture only by utilizing large changes.

Direct Reading Meter

Considering then that d.c. is used for tests, we find that the amplification factor depends on the division of the plate voltage change by the grid voltage change, where the plate current is maintained constant. Note that the plate current is d.c., so is the plate voltage, so is the grid voltage, and no a.c. whatsoever is used. But the plate current and grid voltage changes are to be strictly small, remember, so we approximate the a.c. condition, where a mean voltage and a mean current would exist.

If the grid voltage change is always maintained at 1 volt, then the amplification factor is the change in plate volts necessary to main-

tain the current the same after the one volt grid change as it was before that grid voltage change. This makes for a direct reading mu meter. However, 1 volt may be a very large change in some instances, though small in others. Arrangements to change by .1 volt also should be provided, for high mu tubes particularly, and then the amplification factor would be the plate voltage change multiplied by 10.

Other Voltages Constant

The plate resistance always refers, as said, to the a.c. resistance. And yet d.c. is used for the determination, and by definition the plate resistance is the small change in plate voltage divided by the resultant change in plate current, when the grid voltage is maintained constant. It is always taken for granted, by the way, that other terminal voltages are held constant, and particularly that the filament or heater voltage is just what is recommended, as found on tube charts.

It is obvious we have not measured the a.c. resistance of the tube when we have done what the definition requires, but all we have done is to follow the definition and call the result the plate resistance. To find the a.c. resistance we would put d.c. voltages on the tube as usual, but supply a plate load through which a.c. could be applied, would measure only the a.c., as to voltage and current, and make no changes whatever, simply divide the voltage by the current and have the total resistance, from which the resistance of the load would be subtracted, to yield the plate resistance. But, as stated, for very small changes, the result is not far away by the d.c. method, which, though termed static, is satisfactory and handier. The d.c. method is not used by sheer preference, however, other factors equal.

The Conductance Next

Just as we may use a grid voltage of 1 volt for a means of direct reading mu meter, or .1 volt for a second range, so we may make the plate resistance meter direct reading to the same extent, by holding the plate current change to 1 milliampere or .1 milliampere, written respectively .001 and .0001 ampere, when the plate resistance is the voltage change multiplied by 1,000 (for one mil) or multiplied by 10,000 (for .1 mil).

We come now to the mutual conductance. This is the ratio of a small change in plate current to the change in grid voltage producing that plate current change, plate voltage held constant. Since the conductance is the opposite of resistance, it is not the voltage divided by the current but the current divided by the voltage. When the values are in units of amperes and volts the answer is in mhos. The word mho is obtained by spelling ohm backwards, to suggest the opposite of resistance.

We may make the mutual conductance test direct reading, too, by making the grid voltage change either 1 or .1 volt. The current change is multiplied by 1,000,000, however, so that the

answer will be in millions of mhos, or micro-mhos, as that level fits in more nicely with the figures obtained for the other constants, and renders mathematical application a bit easier.

Using A.C. Inputs

So far we have determined the three principal quantities by following the definitions and using d.c., although the quantities had better be determined by a.c., for which no definitions have been specifically given. We found that the way to measure a.c. resistance

is to use a.c. Also the power test used a.c., hence all we do is to follow the definitions as laid down for d.c. and put a.c. into the grid. Then there is a.c. in a coil-loaded plate circuit, or, for other load, merely pulsating d.c., and this may be measured as a.c., because pulsating, or simply as d.c., plate current con-

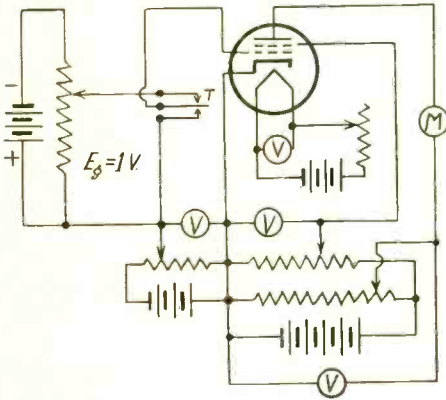

This circuit is intended primarily for a direct reading mutual conductance meter. The various voltmeters are used to show that the various voltages are correct. When the key T is depressed the grid voltage changes by one volt. The change in the reading on meter M gives numerically the mutual conductance. If the amplification factor of the tube is very great it may be necessary to readjust the grid bias change from 1 volt to 0.1 volt. The circuit can also be used for measurement of plate resistance and amplification factor.

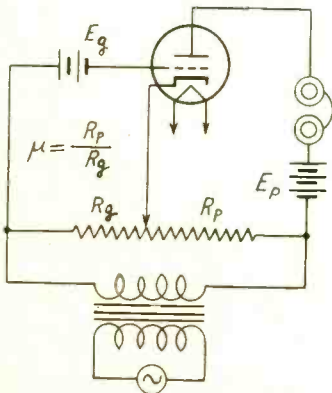

Amplification factor determined by dynamic test. It is equal to the ratio of the resistances of the two parts into which the slider artificially divides the total potentiometer resistance. The right-hand part, Rp, is divided by the left-hand part, Rg, and the answer is the mu. Balance is obtained by minimum sound in phones.

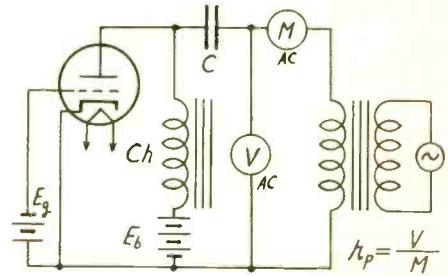

Plate resistance determined by the a.c. or dynamic method. It is equal to the voltage as read on the a.c. voltmeter, V, divided by the current as read on the a.c. current meter M, assuming C has negligible resistance and C very large compared to the frequency negligible series impedance and negligible shunt admittance).

sidered, because for most conditions the d.c. alone in the plate circuit will render the reading sufficiently accurate.

We come then to the conversion conductance. This applies only to mixer tubes and is a comparison of the output i.f. current to the input r.f. voltage, all values again small, even though a.c. is used in both these instances. When the conversion conductance is solved it is treated exactly the same as the mutual conductance of any amplifier or power tube.

Individual Tests Additional

So the tests of the four fundamental characteristics may be made, and these may be in addition to the selected single test. For instance, in service work, a tube is to be checked quickly, and no intimate details, just general results, are required. However, those interested

(Continued on next page)

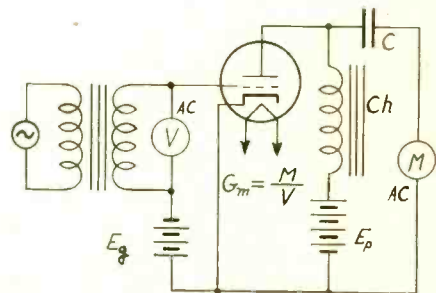

Mutual conductance by the dynamic method. It is equal to the a.c. current as read on M, divided by the a.c. voltage as read across V.

The 6L7 as an Amplifier

Sharp Cutoff Without Crossmodulation

By Capt. Peter V. O'Rourke

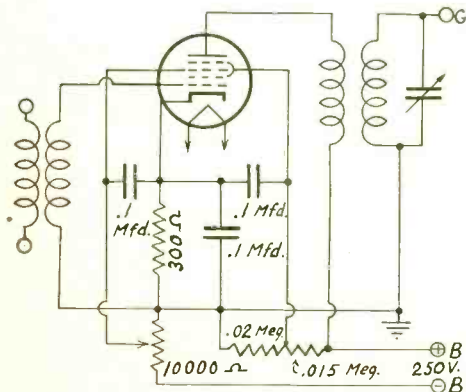

Circuit diagram of 6L7 r.f. or i.f. amplifier.

THE 6L7 serves well as a controlled amplifier tube. It has two control grids, really: G1, which is the usual input grid, and G3, which is the injector grid for mixer practice. However, it is not as a mixer but as an amplifier that the tube is to be discussed now.

G1 has a remote cutoff characteristic, and therefore a large signal may be introduced, e.g., strong carrier, without causing cross-modulation or intermodulation or any other serious distortion effects. Assuming automatic volume control is present, then the G1 return is to the a.v.c. voltage and if G3 is returned to the same voltage, then G3 is d.c. biased only, and as it has a sharp cutoff, the desired effect may be selected.

What would be a desired effect, and why?

For one thing, it might be desired to have the a.v.c. act more sharply, or less sharply. Suppose you want a change due to a.v.c. to be

more gradual. Whatever is desired may be arranged, by connecting the returns of G1 and G3 either together to 15 volts negative (for a conductance of 5 micromhos), steeply arrived at, since a strong local will develop more than that amount of rectified diode voltage at the second detector.

Steepness has its merits, as where one desires to get a marked difference between resonance and off resonance, to get a snappy response from a meter, or other indicator. However, if one desires a.v.c. principally as a fading corrective, then the response should be flatter, and this may be arranged. The smaller the voltage applied to G3 compared to that applied to G1, the less rapid the change. The flattening takes place.

For a.v.c. to be really effective on the other tubes of the receiver it should be applied to all the tubes that will take it

And if there are frequent conditions of more than 15 volts negative being developed across the diode load resistor, wherever the 6L7 is used as amplifier the limitation to 15 volts may be imposed by tapping the diode load resistor (really, using two resistors), so that 15 volts is not exceeded. Otherwise 6L7 would cease to function beyond 15 volts negative, although the other tubes may take the full amount, as they may stand up to 40 volts negative before the conductance drops to 5 micromhos.

As an amplifier the 6L7, at 250 plate volts, takes 3 volts negative bias, 100 volts on the screen, and the screen current and plate current are about equal, about 11 milliamperes total. The transconductance swings from 5 to 1,100 micromhos, depending on the control voltages on Grids 1 and 3. The values given are for volts 15 and 3 volts negative, respectively, for both control grids.

Test Circuit for Conversion Conductance

(Continued from preceding page)

in close accuracy, in building test apparatus, and who make a small laboratory out of their home or workshop, will like to particularize on the testing of tubes, and may do so after having acquired a basic knowledge of the four characteristics that rate vacuum tubes.

Measurement of conversion conductance is made by noting the a.c. in the capacity leg of the first i.f.'s primary, and dividing into it the signal voltage applied to the input grid G1.

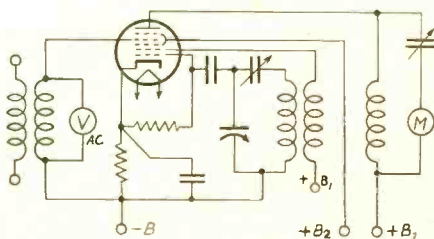

A New Shielding Theory

Impedance Effects of Radial Line Used for Solving Inductive Interference

By Sergei A. Schelkunoff

Bell Telephone Laboratories, Inc.

AMONG the important and often perplexing factors encountered in the design of communication lines are interference and crosstalk. Although any efficient transmission line keeps most of its energy to itself and under any circumstances gives up only small amounts to the neighboring lines, yet these small energy transfers while not affecting appreciably the efficiency of the line may prove very annoying as interference.

In ordinary telephony these troubles are usually overcome by "transposing" at intervals the wires of the communication lines, thereby cancelling most of the induction effects; but in carrier telephony the frequency may be so high as to render this method insufficient and necessitate the use of shields.

The problem of shielding is comparatively simple in principle but efforts to express the concepts involved in quantitative form have long been fraught with difficulties.

New Method of Approach

A method of approach applicable to solid shields is presented here which it is hoped may be helpful, particularly to those accustomed to think in terms of electrical transmission problems. It is based upon the fact that the movement of energy at right angles to communication wires, which is the cause of interference and crosstalk, follows the same basic laws which govern the transfer of energy along a transmission line.

From this point of view an electromagnetic

Classical Adherent

SERGEI A. SCHELKUNOFF began his connection with Bell Telephone Laboratories in 1929. Since that time he has been concerned with applications of the classical electromagnetic theory to various problems in the communication art. Interference and crosstalk studies represent one phase of his work. Prior to 1929 he was an instructor and then an assistant professor at the State College of Washington. His B.A. and M.A. were received at the State College of Washington in 1923 and Ph.D. at Columbia University in 1928.

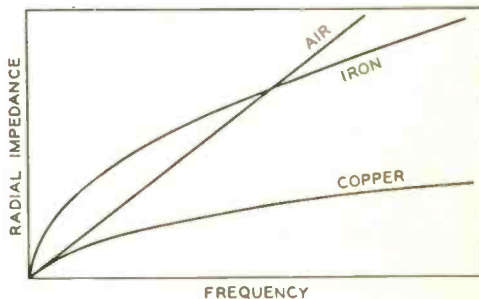

FIG. 1

Radial impedance of all materials increases with frequency; the graph for air and other dielectrics is a straight line; the graphs for magnetic materials, of which only one is shown, are curves which have values greater than those of air for lower frequencies, and less for higher frequencies. The radial impedance of copper and other non-magnetic materials is always less than the value found for air.

disturbance starts from the wires and spreads radially outward through the dielectric surrounding them which constitutes the first section of the radial transmission line. At the shield the electrical characteristics of this line suddenly change and another similar abrupt change occurs when the shield terminates. Outside of the shield the radial transmission line extends indefinitely into space but very little energy is able to reach this section and cause interference if the shield is correctly constructed.

Transmission Line Behavior

Before applying these ideas to the propagation of energy radially let us consider the behavior of an ordinary transmission line. The voltage and the current in this line are in general attenuated on account of energy dissipation. If the line is infinitely long the voltage-current ratio is the same at all points; this ratio is called the characteristic impedance.

Let us suppose that beyond a certain point the given line is replaced by a section with a different characteristic impedance. A reflection will take place at the junction between the two lines. In other words, when a wave

(Continued on next page)

(Continued from preceding page)

traveling along the line encounters a sudden change in the medium of transmission, a wave in the backward direction originates at the point of discontinuity. The only time when there is no reflection is when the characteristic impedance of the second line equals that of the first line, that is, when the impedances are matched. Under all other circumstances there will be a reflection and the reflection coefficient can then be easily calculated from the ratio of the two impedances.

Although the behavior of an electro-magnetic wave traveling along a transmission line is usually described in terms of the voltage and current, it could also be expressed as a function of the electric intensity E and the magnetic intensity H . The measurements of voltage and current are so easily made, however, compared with those of E and H , that the former are used exclusively in practice; but when we have to deal with radial transmission lines which have no wires to carry the conduction current, the variation of E and H along a radius is all that is available to measure.

The Radial Impedance

Returning then to a consideration of the radial transmission line the electro-magnetic disturbance may be thought of as originating in a pair of wires and spreading radially outwards. This actual source can be replaced without introducing serious errors by a line source midway between the wires. The outward progress of the radial wave originating from this line source can be fully described by an electric intensity E parallel to the wires and by a magnetic intensity H perpendicular to both the wires and the radius from the line source to the point under consideration. The ratio of E to H may be called the radial impedance.

In a dielectric the radial impedance at a point whose distance from the axis is ρ is $i\omega\mu\rho$ ohms, provided ρ is short in comparison with the wavelength. In metals on the other hand it is equal to $\sqrt{i\omega\mu/g}$ ohms*, unless the frequency is very low. At low frequencies the radial impedance of metals is also $i\omega\mu\rho$ ohms. The variation of radial impedances with the frequency is shown in Fig. 1.

The Example of Metallic Case

In their progress through metallic substances radial electromagnetic waves are attenuated at the rate $\alpha = \sqrt{\pi\mu fg}$ nepers/cm. This attenuation is caused by transformation of electric energy into heat and is so great, except at very low frequencies, as to mask altogether the slight attenuation due to the divergence of the waves.† In copper $\mu = 1.257 (10^{-8})$ and $g = 5.80 (10^{-5})$ so that the attenuation constant at 10,000 cycles is about 15 nepers or 130 db/cm.

The effectiveness of a shield is due in part to this rapid attenuation and in part to the reflection occurring at the boundaries of the shield because of the difference in radial impedances of the shield and adjacent dielectric. Comparing the expressions for impedances, we see that the reflection loss between two metals or two dielectrics is independent of the frequency, but it is not so between a metal and a dielectric. As shown in Fig. 1, the radial impedance of copper is very much lower than that of air, while the radial impedance of iron is at one frequency equal in magnitude to that of air.** This means that while at a certain frequency there is practically no reflection between iron and air, there will be a very large reflection between copper and air. Hence, for sufficiently thin shields the higher attenuation loss of iron, as computed by the formula $\alpha = \sqrt{\pi\mu fg}$, may be more than offset by the greater reflection loss at copper-air boundaries.

Alternate Layers

An interesting and at first sight curious

(Continued on next page)

*The quantity $i = \sqrt{-1}$, ω is $2\pi \times$ the frequency f , and μ is the permeability in henries/cm. In vacuum $\mu = 4\pi 10^{-9}$ henries/cm = $1.257 (10^{-8})$ henries/cm. The quantity g is the conductivity in mhos/cm.

†In perfect dielectrics "attenuation" is due entirely to the divergence of the waves.

**The phases of the two impedances are different, however, so that at this point the reflection loss is not quite zero as it otherwise would be if the impedances were exactly equal.

TABLE I—Experimental data on shielding obtained by W. E. Mougey and his associates in the Cable Development group. The last two columns show the remarkable agreement between the calculated and experimental values

MATERIAL	THICKNESS <i>Mils</i>	FREQUENCY <i>kc</i>	CALCULATED LOSS			MEASURED LOSS
			ATTENUATION <i>db</i>	REFLECTION <i>db</i>	TOTAL <i>db</i>	
Copper	16	80	15.1	27.6	42.7	43.7
		150	20.7	31.3	52.0	52.1
Aluminum	18	80	13.3	26.5	39.8	39.8
		150	18.2	29.2	47.4	47.6
Zinc	18	80	9.3	23.4	32.7	32.0
		150	12.7	26.1	38.8	38.5
Lead	86	80	22.5	17.5	40.0	40.3
		150	30.8	22.0	52.8	52.3

How to Make A.V.C. Cut Fading

WHAT is the method of using automatic volume control that makes it a real aid in the reduction of fading effects?

While a.v.c. is not a cure for fading, it may be a corrective, if applied properly. The requirement is that the receiver be a multi-tube affair and that all tubes be controlled by a.v.c. where that is practical. Audio tubes are ruled out. Also the oscillator in a superheterodyne is not subject to the control. However, all other tubes are, by returning their grids to the full a.v.c., although less than the full voltage of the detector is taken off for delivery to the audio channel. For instance, if the diode detector normally has load resistor of 500,000 ohms, then 250,000 ohms may be put in series, the total sum resistance, 750,000 ohms, between coil return and cathode, the a.v.c. controlled circuits being connected through suitable filters

to the *joint of coil and resistor* in the diode rectifier, and the audio voltage being taken off from the *joint of the two resistors*. This may be done by connecting the stopping condenser to this joint, and having a leak in the succeeding grid circuit, or by connecting the joint directly to a grid, the cathode of the tube or tubes being grounded. The last-named method employs direct coupling and the amplifier thus direct coupled should not have early cutoff, otherwise on strong signals there will be distortion, and on stronger ones, no reception until the manual volume control is retarded. The reason for controlling all possible tubes with a.v.c. is that when one or more tubes are not controlled that should be, they tend to nullify the effect of a.v.c. Perhaps as many tubes are operated without it as with it, hence there would be only 50 per cent. control.

Why and When of Rectification

THE statement is made that a rectifier will rectify only when the plate is positive. There is a load resistor, and the d.c. polarity is such that the cathode side of the load resistor is positive to d.c., the other terminal of the resistor negative to d.c. It is clear that the d.c. bucks the a.c. during the positive a.c. alternation. Why does not rectification therefore stop even on the positive alternation?

The rectifier will conduct when the net effect is to leave its plate potential positive, no matter what circumstances intervene to make it less positive than it might be otherwise. Therefore the a.c. during the positive cycle establishes a certain instantaneous voltage on the plate, direct current flows, and the side of the load resistor toward the plate is negative to d.c.

But it is not as negative as the a.c. is positive. It must be remembered, also, that the a.c. is a changing voltage, i.e., the amplitude varies from peak to zero. The rectified component is .636 of the a.c. voltage that causes the rectification, and the proportion holds of course during the entire positive alternation or half-cycle. If the load resistance is very high compared to the tube's conducting resistance, then the .636 factor may be applied generally to the a.c. to determine the rectified voltage, or the a.c. is 1.575 times the d.c. It is easier to determine the d.c. accurately by measuring the direct current and multiplying it by the resistance through which it passes, assuming the load is very high compared to the tube's conducting resistance.

Composite Layers for Shielding

(Continued from preceding page)

phenomenon is explained by the ratios between the impedances of different substances. If a composite shield is made of alternate layers of copper and iron the effectiveness of the shield is very much greater when the outside layers are made of copper. This is because of the higher reflection loss between copper and air, the attenuation loss being independent of the arrangement of layers.

Another interesting fact is that while non-magnetic shields become increasingly effective with increase of frequency this is not always true with magnetic shields. At low frequencies magnetic shields are very efficient. As the frequency increases they sometimes become less effective but ultimately reach a minimum beyond which they improve again so that at sufficiently high frequencies they are always better than

non-magnetic shields. These characteristics are due to the manner in which the impedances mismatch, as previously explained. In the case of non-magnetic shields the impedances of the shield and dielectric are always mismatched except for zero frequency and by an amount which increases with the frequency as shown in Fig. 1. For magnetic shields the mismatch is large at low and high frequencies but is small at certain intermediate points.

The method of explaining inductive interference and shielding effects in terms of the impedance characteristics of a radial transmission line as here outlined has been tested by extensive experiments on shielding carried out at the Laboratories by W. E. Mougey and his associates. The results show a remarkable agreement between the calculated and experimental values as is shown in the accompanying table.

OCTAL SOCKET PIN ARRANGEMENTS

[Bottom View of Sockets is Shown]

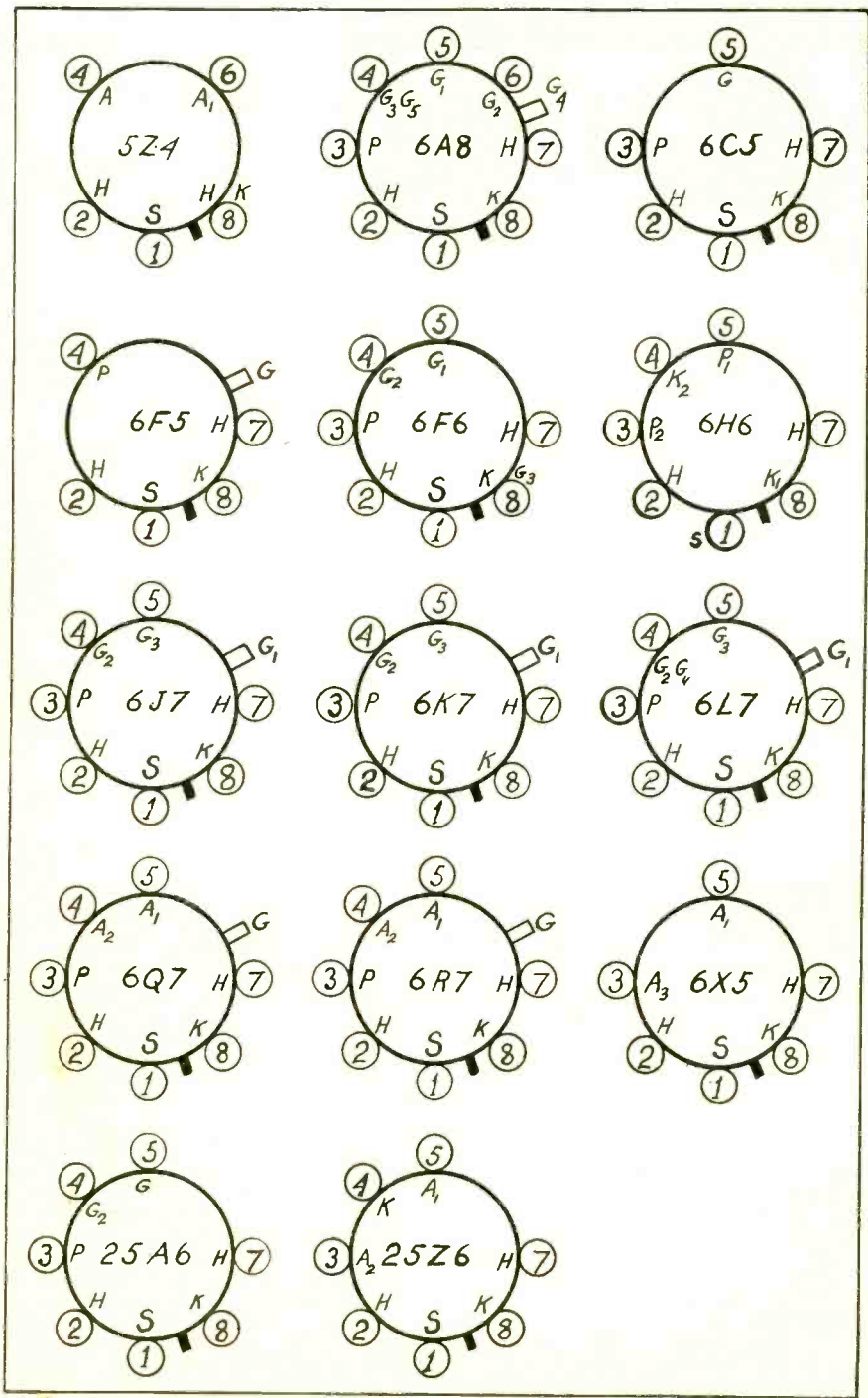

SERVICE BUREAU

How to Keep in Mind Identities of Metal Tube Pins

By Ralph Kingsway

SUFFICIENT uniformity exists regarding the pins of the all-metal tubes to make the memorization of the connections not very difficult. The pins are numbered from 1 to 8, inclusive, in clockwise rotation. The reference position is the keyway, a slot at the center hole of the socket, into which slot a small protrusion, called the key, fits snugly. The tube has an insulated cylinder at bottom center, called the aligning plug, which fits into the center opening of the socket. The key is the protrusion on this plug. This socket keyway enables the key to act as a locator and it is not possible to put any metal tube into a socket the wrong way. It is, however, possible to break a shell type socket, so no great force should be used in trying to make an erroneous insertion. The tube should fit into the socket with medium pressure, and if it doesn't, turn the tube around until the locator is picked up, when a firm press will insure the insertion. The insertion resistance is somewhat greater than with previous tubes, for socket reasons.

In every one of the tubes so far position No. 1, which is the first one after the key in a clockwise direction, represents the shell, or metal cover of the tube, which cover is permanently affixed, in fact, this is what supplants the familiar glass envelope. While it serves no purpose to ground a piece of glass, it is necessary to ground a piece of metal, for this serves as shield, so one of the pins, and it is No. 1, picks up the shell, or metal itself, and is to be grounded, or, in some circuits, may go to cathode.

Letter Designations

Position No. 2 represents one of the heater connections, and to this likewise there is no exception. All the metal tubes are of the heater type, even the 5Z4 rectifier. So everybody who reads this now knows two of the nine possible connections, leaving only seven more to learn, and since one of these would be the grid cap, the metal piece atop some types of tubes, there are really only six more to consider from the viewpoint of memorization.

The third position is occupied by the plate, in all instances save two: the rectifier tube 5Z4, and the high mu triode 6F5. So if we shall remember the rectifier and triode as the ex-

ceptions, we may say that we know the identities of Nos. 1 as shell, 2 as heater and 3 as plate. Since two tubes have diodes in them, the word "plate" will be used to refer to the plate of an amplifier. Hence to avoid confusion due to the word plate, which also could be applied to an element of a diode, we may call the corresponding diode element the anode in any tabulation, including "plates" of line rectifiers.

The letter designations so far would be S = shell, H = heater, P = plate and A = anode.

If there are to be more than one plate, anode or other element, we may use subscripts, e.g., P₁ and P₂, A₁ and A₂, to distinguish the two, which in each instance so far would be equal.

Fourth Place Dissected

When we come to Pin No. 4 we meet with diversity. It is this pin that represents one of the anodes of the 5Z4, one exception noted above to the rule that No. 3 is a plate. Now we know not only that there is an exception but that this exception simply moves plate from No. 3 to No. 4, or over one position. Another exception, 6F5, also moves plate from the expected Position No. 3 to Position No. 4. The third exception is that No. 4 is one cathode of the 25Z6.

Incidentally, if there are two grids, plates or anodes, and they are to be found in the fourth position, then the one that is identified as the second plate (P₂) or the second anode (A₂) is the one in fourth place. The 5Z4, 6Q7, 6R7 and 25A6 are the examples. Also, grids joined inside the tube are found in fourth place, G₃ and G₅ for the 6A8 and G₂ and G₄ for the 6L7, these constituting the "screen." Positive voltaged grids are in fourth position, except G₂ of the 6A6, in sixth place, though positive.

Questions and Answers

A few questions now about what has been discussed so far. What position is occupied by the shell connector of the 5Z4 and the 6Q7, compared to the shell connector of the 6F5 and the 6K7? Answer: the shell occupies Pin Position No. 1 on these tubes, and on all other metal tubes.

And what are the connections to No. 2 for
(Continued on next page)

Positions, Numbers and Purposes of Pins on All Metal Tubes

Type	1	2	3	4	5	6	7	8	Cap
5Z4	S	H	—	A	—	A ₁	—	H, K	—
6A8	S	H	P	G ₃ , G ₅	G ₁	G ₂	H	K	G ₄
6F5	S	H	P	—	G	—	H	K	—
6F6	S	H	—	P	—	—	H	K	G
6H6	S	H	P	G ₂	G ₁	—	H	K, G ₃	—
6K7	S	H	P	K ₂	P ₁	—	H	K ₁	—
6L7	S	H	P	G ₂	G ₃	—	H	K	G ₁
6Q7	S	H	P	G ₂	G ₃	—	H	K	G ₁
6R7	S	H	P	G ₂	G ₃	—	H	K	G ₁
6X5	S	H	A ₂	A ₂	A ₁	—	H	K	G
25A6	S	H	P	A ₂	A ₁	—	H	K	—
25Z6	S	H	A ₂	G ₂	G	—	H	K	—

S = shell
H = heater
P = plate
G = grid
A = anode
K = cathode

(Continued from preceding page)

the 6K7 and 6H6? The connections are to one side of the heater. This is true of all the metal tubes.

Third Pin Position

Is the third pin position representative of the plate? If not, state why. Answer: Position No. 3 represents the plate as a rule, the exceptions being the 5Z4 and 6F5, where the third pin position is not used at all, and plate is moved to fourth place. In the case of the 6H6 position No. 3 represents one of two diode plates, which we shall call anodes for distinction.

What elements usually occupy Position No. 4? Answer: Elements that require a positive voltage. If tubes have a screen, or a pair of grids joined inside the tube to shield two other elements, hence double screen, this is represented likewise by the fourth position.

From Fifth to Eighth Pins

Now to go on with an exposition of the pin positions, starting this time with the fifth. If the tube has a control grid, and no grid cap, then G or G₁ is found in fifth position. G is the control grid designation when there is only one grid. G₁ is the control grid designation when there are more than one grid. In the cases of the 6A8 and the 6L7, tubes for mixer use principally, G₄ of the 6A8 is the control grid (cap) and G₃ of the 6L7 is the coupling grid, pickup grid or injector grid, different terms applied to bring out the same idea. Hence for these two, control grid is neither G nor G₁. Besides the 6L7 has two control grids, G₁ and G₂.

Position 6 is easy, since it is used only for one plate of the rectifier 5Z4 and G₂ of the 6A8. It is blank for all other tubes.

Position 7 is still easier, as it represents the second heater connection, there being only one

exception, that of the rectifier 5Z4 again, for which it is not used.

No. 8 is easy, too, as it always represents at least cathode, otherwise cathode and whatever other element inside the tube is joined to cathode. However, it need be treated only as cathode, as the other connection is made at the factory. For instance, the rectifier 5Z4 has heater and cathode joined at Position 8, the 5Z4 heater being remembered as the only exception to the rule that seventh place always takes care of a heater.

G₃, a suppressor, is connected to cathode at No. 8 in the 6F6 and is automatically connected in circuit when cathode is connected. Also 6L7 has a suppressor likewise taken care of at this position, being a cathode adjunct.

The Grid Cap

The only remaining connection is not a socket pin but an overhead cap, always representing a grid, in fact, always a control grid. It is G₄ in the 6A8. G in the 6F5, 6R7 and 6Q7, and G₁ in the 6J7, 6K7 and 6L7. It will be remembered that G₁ represents control grid, the same as G does, but for a tube that has more than one grid, exceptions, as noted, 6L7 and 6A8.

Now for some questions and answers on pins from No. 5 to No. 8, inclusive, and working in the grid cap, too.

What tubes do not use Pin 5? Answer: The 5Z4 and the 6F5.

What is the use to which fifth position is put where a tube has two plates or anodes? Answer: The rule is that one of the two plates or anodes will be found in fifth position, the exceptions being the 5Z4, because, as has been stated in answer to the previous question, fifth position is not used, the other plate mentioned being in sixth place for the rectifier.

Five Pin Arrangements

What is the pin number for the second heater connection of the 6Q7 and the 6H6, assuming the first heater connection is at position 2? Answer: The second heater connection is at seventh place. This is true of all tubes save the 5Z4, where it is with cathode at 8.

What element is always associated with eighth position? If any other element also is associated with that position, state why. Answer: Cathode always is associated with eighth place, and if some other element also is concerned, it is because that other element is connected to cathode inside the tube.

It should be observed that five pin base has two different arrangements: (a) 1, 2, 4, 6 and 8, as in 5Z4; (b), 1, 2, 4, 7 and 8, as 6F5.

5Z4 All Metal and Smaller

A smaller sized 5Z4 rectifier with metal shell supersedes the 5Z4 having the metal cage construction. The new type, although much smaller, has the same electrical characteristics as the superseded type, and the same base connections.

Tabulated Characteristics of the Fourteen Metal Tubes

Type	Use	Filament Rating		Plate Volts	Negative Grid Volts	Screen Volts	Plate Current ma.	Screen Current ma.	Plate Resistance Ohms	Mutual Conductance Micromhos	Amplification Factor	Load Resistance Ohms	Milliwatts Undistorted Output	Similar Type
		Volts.	Amps.											
5Z4	F. W. Rectifier	5.0	2.0	400 RMS.	125	80
6A8	Converter	6.3	0.3	250	3.0	100	3.3	3.2	500,000	†500	6A7
6C5	Amplifier	6.3	0.3	250	8.0	8.0	..	10,000	2,000	14	76
6F5	Amplifier	6.3	0.3	250	2.0	0.9	..	10,000	1,500	50-60	*
6F6	Pentode	6.3	0.7	250	16.5	250	34.0	6.5	80,000	2,500	200	7,000	3,000	42
	Triode†	6.3	0.7	250	20.0	...	31.0	..	2,600	2,700	7	4,000	850	..
6H6	Rectifier	6.3	0.3	100 RMS, Max.	2.0 Max.	*
6J7	Detector, Amplifier	6.3	0.3	250	3.0	100	2.0	0.5	1,500,000	1,225	1,500	77
6K7	Amplifier	6.3	0.3	250	3.0	100	7.0	1.7	600,000	1,650	1,160	78
6L7	Mixer	6.3	0.3	250	6.0	150	3.3	8.0	1,000,000	†325	None
6Q7	Dual Diode, triode.	6.3	0.3	250	3.0	...	1.1	..	58,000	1,200	70	75
6R7	Dual Diode, triode.	6.3	0.3	250	9.0	...	9.5	..	8,500	1,900	16	85
6X5	F. W. Rectifier	6.3	0.6	350 RMS, Max.	75 Max.	84
25A6	Pentode	25	0.3	180	20	132	40	8	40,000	2,400	95	5,000	2,750	43
25Z6	F. W. Rectifier	25	0.3	125 RMS, Max.	85 Max.	25Z5

*6F5 corresponds to triode of 75 while 6H6 corresponds to the diode of 75.

†Screen tied to plate.

‡Conversion conductance.

Note: The 6D5 triode (like 45) has been dropped.

RADIO CONSTRUCTION UNIVERSITY

Answers to Questions on the Building and Servicing of Radio and Allied Devices.

VOLUME EXPANDER EXPLAINED

KINDLY explain the volume expander, using the rectifier tube.—K. L.

The volume expander, for a phonograph amplifier particularly, but also applicable to a receiver, is intended to correct for the compression of volume when a rendition is recorded or put on the air. The possible amplitude is strictly limited in a phonograph recording in particular. Passages that would require more

tortion, and if the capability is 100 per cent. modulation, unless monitoring is carefully practiced, more than 100 per cent. modulation (that is, distortion) would be present.

* * *

CHASSIS AS HEATER FEED

WILL you kindly let me know if it is proper to ground one side of the heater

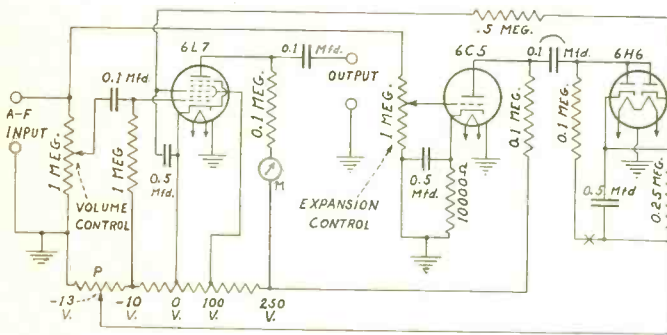

The explanation of how this volume expander works is given in answer to a question by K. L. In general, input is combined in the 6L7 and the 6C5. Output is taken from the 6L7. The 6C5 feeds a diode detector. The greater the a.f. input the much greater the a.f. output, for reasons set forth in the answer.

energy than the system is capable of taking are monitored down, and the problem is to restore these suppressed parts, or expand the compressed passages. This is done by connecting pickup input to two tubes, G1 of the 6L7 and G of the 6C5, using 6L7 output for listening, and rectifying the 6C5 output, connecting negative of the rectifier load resistor to a minus voltage, and positive to G3 of the 6L7. Now when the pickup feeds the expander, the 6L7 acts as a controlled amplifier. The control is the voltage on G3. When the pickup itself delivers greater input, G3 is made less negative, because the steady negative bias value is bucked by the rectified component, hence the louder the louder, so to speak. Input should be limited to one volt, to avoid distortion due to the G1 characteristic of the 6L7. P is the potentiometer that, once set to the desired volume, depending on room noise and personal choice, need not be changed. The system is applicable to receivers, too, because compression is practiced in broadcasting studios, where monitoring is just as carefully carried out, to avoid modulating beyond the capabilities of the transmitter. Any modulation beyond that capability is dis-

winding of a power transformer, so that only one wire need be run from one side of the winding to one side of all heaters, other sides of heaters connected to chassis, to which the other side of the winding is soldered? —K. C. M.

Yes, this may be done, and it is a practice resorted to by many. However, instead of merely soldering to chassis, which in general is not a recommended practice, it would be wise to make a strong mechanical joint between one side of the winding and chassis, then solder besides, if you like. The resistance of connections has to be extremely low, as considerable current is flowing.

* * *

DIRECTION OF CURRENT FLOW

AGAIN I wish to ask you, does direct current flow from negative to positive, or from positive to negative? I have seen the statement made both ways and it is confusing. Can the direction be changed?—S. C. A.

Direct current flows in fact from negative to positive. The circuit in which this takes place is the load circuit, always meant, unless

otherwise stated. The other circuit is the source, be it battery or other such supply. In the supply circuit the same direction of current flow prevails, but the signs are changed by the very nature of the electrical connections made, and the flow is described in the supply as from positive to negative. This same seeming confusion might arise in considering a clock, if one said that when the hands read ten minutes past twelve the minute hand was moving to the right, but when the clock read twenty minutes past twelve the minute hand was moving to the left. It is not a question of left and right with a clock movement, but of clockwise rotation, and the same is true of current. If current flow is considered on the same basis, with positive as the starting point, then movement, which can be in only one direction, is clockwise. Using the hour hand as reference,

with which it is to be used (switching from one to the other as needed), also to pick up coils for two bands. The antenna coil is a single winding. I want the converter power to be turned off when the switch puts the antenna to the set.—I. R.

The diagram herewith shows such a switching arrangement, where the 2A7 is the tube used for oscillation and mixing, and an 80 is the rectifier. A four deck three position switch is needed.

* * *

OSCILLATOR GRID VOLTAGE

IS the grid permanently negative in a leak-condenser oscillator?—F. R. C.

While the oscillator is functioning the negative bias on the grid for any setting of the condenser is a steady d.c. value, applicable to the negative alternation as well as the positive

Switching arrangement (1) connects power and antenna to converter and leaves these inputs present when the converter is in use; (2) removes power and antenna from converter and connects antenna instead to the set, when converter is not in use; (3) accommodates two bands of short wave tuning coils.

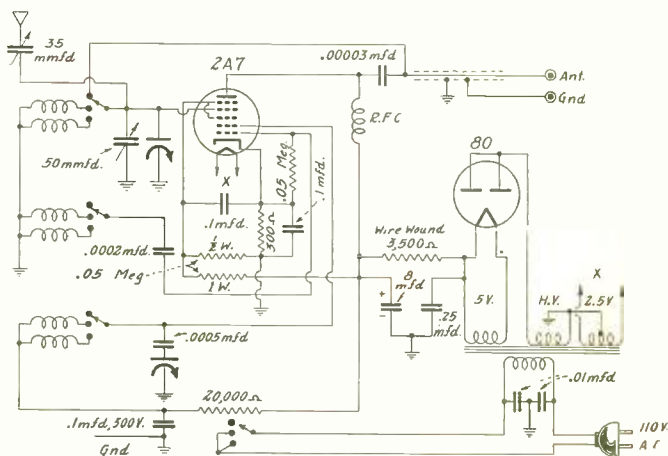

let 9 to 3 equal the load circuit and 3 to 9 the supply circuit, all in a clockwise direction. Notice that as the hour hand turns past 3 the movement is from negative to positive, but still the direction is the same, clockwise. Also, earlier notions of current direction, and on which meters and formulas are based, had the current movement wrongly from positive to negative in the circuit that drew the current. This still prevails as the conventional designation because it was easier to let the formulas and meters stand as they were, and adopt the convention, though fallacious, than to make the revolutionary change. Yet it is necessary to realize for a substantial understanding of electricity what is the true direction of current flow—negative to positive—as contrasted with the conventional direction accepted with the unchallenged knowledge of to-day that it is really wrong. The direction in fact cannot be changed.

* * *

CONVERTER SWITCHING

WILL you kindly show a circuit including a switch that will enable me to connect antenna to a short wave converter or to the set

alternation, due to the mean value established through charge and discharge of the grid condenser. If the grid condenser is not large enough an effect is produced akin to removal of one of the sidebands. This is noticed when tuning to zero beat. When approaching zero beat on one side, the positive one, the usual decline in the frequency of the beat (not intensity of the beat) is noted. When attempting to reproduce the effect in reverse when going past zero beat to the other side, no beat is heard.

* * *

METAL TUBES O. K.

MY friends are asking me whether the metal tubes are any good, as there have been statements both ways.—R. B.

Yes, they are good; indeed, very good. No doubt, due to the uniqueness and early difficulty of construction, there was some manufacturing trouble with some of the models at first, but metal tube production is now going full blast, to wide public and engineering acceptance, and experts who know what the tubes can do and can not do are specifying them right along. The

(Continued on next page)

RCA Field Test of Television Due In About a Month

The Radio Corporation of America will begin first field tests of television in about a month.

The television transmitter will be on the Empire State Building, in New York City.

The annual report of the corporation sets forth:

"The New York area has been selected as the one in which the experimental field tests will be conducted. Test receivers will be operated by technical personnel of the RCA organization throughout this area. The transmitter will be connected by radio with the television studio, now under construction in the NBC plant, RCA Building, in Radio City, New York. The installation is practically complete, and within a month or two the first tests should commence.

Camera Utility One Factor

"This does not mean that regular television service is at hand. It will be necessary to co-ordinate a number of important elements before television on a regular basis of service can be established. For example, it will have to be determined how far the transmitter can send good television pictures; also with what consistency and regularity pictures may be transmitted with the system in its present state of development. We must investigate and define the possibilities of the television camera for indoor and outdoor pick-up.

"These are the essential pioneering stages in the development of an art in which considerable expenditures must be made for research before returns can be expected. As the work goes on, it may be necessary to return to the laboratory, from time to time, to seek the solution to practical problems encountered in the field.

Confident of Progress

"But the RCA experimental television project is proceeding on schedule, and your management is confident that it will continue to progress at an encouraging rate.

"It is, however, evident that, regardless of the progress in this direction, the present system of sound broadcasting remains the fundamental service of radio communication to the home. While television promises to supplement the present service of broadcasting by adding sight to sound, it will not supplant nor diminish the importance and usefulness of broadcasting by sound."

ARMY PLANES RADIOIZED

Washington.

All the war planes in the Army are now radio equipped, 1,150 of them. A small set for infantrymen to carry on their backs, with a mile range, has been developed.

Germany Opens Television 'Phone; 3 Minutes, \$1.40

Berlin.

The world's first television-telephone service has been inaugurated between this city and Leipzig. At \$1.40 for three minutes you may see whom you talk to and talk to whom you see. The service was inaugurated to mark the opening of the Leipzig Spring Fair.

A couple of hundred miles of cable are used between the two cities for conducting the voice and video frequencies. The television scanning is on the basis of 180 lines per picture, 25 pictures per second, or a scanning frequency of 4,500 per second.

The results are experimental, representing about the same state of development as exists in the United States and England, where no such service is attempted, due to inferiority of the pictures to commercial purposes and the terrific expense. The rate charged is only a fraction of the cost and the whole project looks more like a publicity stunt than a scientific advance. The United States did better in an experimental setup to which the public flocked a few years ago. So much money was spent that some officials got scolded for the venture, long since dropped.

Two Booths in Each City

There are in each of the two cities two booths, each about five times as large as a telephone booth in the United States. You sit in a leather-upholstered wing chair and before you is a microphone, while you pick up an earpiece to hear what's being said at the other end. On the other side of a glass partition, about 10 feet away, is the viewing screen, 9 inches wide by 8 inches high, whence comes the kick of seeing some one you know, who at the same time is talking to you. If he has a long nose, a bald head or other aid you can recognize him better. The pictures were not good enough to constitute looking-in as anything but a lark for the present.

Improvements Promised

The visual imperfections are freely admitted by the German Postal Ministry, and improvements are promised, when the scanning frequency is increased. Due to the present use of 180 lines at a viewing distance of 10 feet, and a picture frequency beyond the flicker limit, an innocent radio engineer might suspect some trouble in the transmission, especially due to the distance and the concentric cable, the development of which for this purpose is rather new.

In fact, it is newer than the laboratory experiments of Bell Telephone in the United States with the same general type of cable, one copper tubing within another, outside one grounded, inside one used as conductor, although the inside tubing may be replaced with solid but flexible wire.

How Octal Sockets Affect Servicing

By Edward E. Weir

A uniform socket is applicable to the all-metal tubes, also to metal-glass tubes and to exclusively glass tubes that use the same type base and pin arrangements as do the two others.

The maximum number of base pins, or socket holes, is eight. Therefore if all sockets had eight holes, the eight pin tube could be inserted, as well as the others. If there was a socket connector for each socket hole then any of the tubes could be actually used with the socket that then would be truly universal.

However, it is expensive to equip the sockets with all eight connectors for service which may not require the full eight. Also, since only one tube so far requires all eight connections made at the base—the 6A8—a socket with seven connectors would be universal, with one exception. Where sockets not bearing tube type designation are used for an assortment of metal tubes, at least the eighth connector is omitted for large users of sockets who, when they want to use a 6A8, have a full eight-connector socket for that purpose alone.

Since all the tubes would fit into a universal socket it would be possible to insert a tube in a circuit position that not only was erroneous but that also could cause serious injury to parts in a set, perhaps even blow out condensers or short primaries or secondaries of transformers, even burn them out, due to overload. To minimize this peril, sockets may be marked with the type number of the tube, while others, marked or not marked, may be punched only for the number of pins on the tube. This restricted punching, or blanking, makes servicing more complicated, because of adapters needed for an analyzer plug.

The all-glass tubes using metal tube pins and sockets have no occasion for Pin No. 1, as this is the shell pin and the tubes have no metal shell.

Naval Time Signals at Noon on Short Waves

Time signals from the United States Naval Observatory in Washington are broadcast daily by short waves from Arlington, Va., at 11:58 a.m. and are on the following frequencies: 8,150 and 12,225 and 16,300 kilocycles.

The broadcasts start with a series of one-second signals preliminary to sending the noon signal, which lasts exactly three tenths of a second and starts at noon sharp after a period of ten seconds of silence.

The time signals are sent out by automatic transmitters controlled from the Naval Observatory and are based upon intricate astronomical calculations. They give Eastern Standard Time to within one-thousandth of a second.

LITERATURE WANTED

Readers whose names and addresses are printed herewith desire trade literature on parts and apparatus for use in radio construction. Readers desiring their names and addresses listed should send their request on postcard or in letter to Literature Editor, Radio World, 145 West Forty-fifth Street, New York, N. Y.

Paul Cady, Jr., Opr., SWL, 421 Meeker St., South Orange, N. J. (on P.A. Systems and Receivers).

J. W. Peirce, Box 141, Kenly, N. C.
Theodore R. Furman, W3FJ.S., 1453 Dorchester Rd., Upper Darby, Pa.

Geo. F. Baptiste (on Radio Equipment and Accessories), Radio Service, P.O. Box 114, Howard, R. I.
Jos. H. Stephenson (on parts and apparatus for use in radio construction), Box 522, Madison, Wis.

R. W. Kool, 120 North Third St., DeKalb, Ills. (parts and apparatus for use in radio construction).

Narl R. Avery, P.O. Box 292, Huntingburg, Ind. (on parts and apparatus for use in radio construction).

Ted Branting, Novelty Radio Shop of Bauxite, 8a Gibbons Road, Bauxite, Ark. (on parts, lists and costs of various inexpensive all electric short wave sets. i.e., kits and assembled sets).

J. R. Oakley, 1411 Bryson St., Youngstown, Ohio.

E. E. Wimer, 795 Geary St., San Francisco, Calif.
Jack A. Dwork, Secretary, The American Hobby Society, 619 West 136th St., New York, N. Y. (on Amateur Broadcasting).

Lt. F. G. Rothwel, 23rd Infantry, Fort Sam Houston, Texas (on Short Wave sets, parts, and accessories).
Martin Erickson, 36 No. 12th St., Minneapolis, Minn. (on radio parts, especially coils).

Harry W. Pascual, 3 Santa Ana St., Stop 24, San-turce, Puerto Rico.

Lou's Radio, F. S. Latson, 3707 North Broad St., Philadelphia, Pa.

M. Cooper's Palace, Orchard Park, Ill.

R. H. Hilgers, Abilene, Kans.

John L. Rose, 790 Main St., Cambridge, Mass. (on all branches, from servicing to Government operating).

K. E. Smith, 536 N. Ninth St., Reading, Pa.

Robert A. Tetrault, 1587 MacGregor St., Montreal, P.Q., Canada (on parts and apparatus for use in radio construction).

Clarence C. Fuller, Loxley, Ala.

Anthony Patruska, 84 Jefferson St., Passaic, N. J.

Carl Barbagal, 56 Mainsgate St., Crafton, Pa.

Shor Radio Service, 2922 Violet Ave., Baltimore, Md.

Frank Goodwin, Kirkwood, Mo.

George Jackson, 2037 Frankford Ave., Philadelphia, Pa.

Glenn Godwin, 5 Mildred, Binghamton, N. Y.

R. A. Soeters, 15816 Prairie Ave., Detroit, Mich.

Ben Tayler, R. No. 1, Phillips, Wis.

N. D. Brumgard, Mason City, Iowa.

Joseph C. Wunderlich, 802 E. Webster St., Clinton, Ill.

John Pickeral, 4640 Broadway, New York City.

Dale Cain, 4685 Montclair, Detroit, Mich.

L. O. Haight, Farmington, West Va.

Wootton's Radio Service, Box 32, Talihina, Okla.

Frank O'Neill, 31 Halsey St., Brooklyn, N. Y.

Garland A. Milam, Knoxville, Tex.

V. F. Daidone, 212 Fairmount Ave., Newark, N. J.

T. H. Bather, 270 Hancock Ave., Jersey City, N. J.

Ekleberry Radio Shop, 1241 N. La Brea Ave., Hollywood, Calif.

Peyton R. Randolph, Forest Glen, Calif.

Rev. F. J. Kett, 27 Duane St., New York City.

Roscoe Spence, 309 East Fourth Street, Emporium,

Penna.—on 20, 40 and 80 meter transmitters.

Herbert Hyde, 2111 N. Clay St., Springfield, Mo.

Ross Whitworth, 121 S. Broadway, Springfield, Mo.

Max Hyde, 1211 N. Clay St., Springfield, Mo.

Russell Butler, 219 Midland Ave., Findlay, Ohio

J. E. Canetti & Cie, 118 Avenue Ledru-Rollin, Paris,

Ille., France

RADIO PARTS FOR HAMS

Sylvania H. F. 210, Isolantite base..... **\$1.95**

Auto Transformer for adjusting line voltage from 90-135 V-15 amp. capacity **\$4.95**

Transformers, manufactured for us by U. T. C., and fully guaranteed.

Filament Transformers

- 2½ V. 3 amp. **59c**
- 2½ V. 20 amp. **92c**
- or 4-866 **\$1.49**
- 6.3 V. 3 amp. **99c**

Plate Transformers

700—700 Volts, delivers 550 Volts, 350 M. A. **\$11.95**

Power Transformers

8 tube power transformer, pri tapped, 110, 120, 220. Sec. 375-375 6.3 V.-5 V. **\$125**

Famous Micianul Condensers

- 1 mfd. 2000 V. **\$1.49**
- 2 mfd. 2000 V. **\$2.19**
- Frost 2000 ohm phones..... **\$1.49**
- Rola K12 12" Speaker..... **\$3.75**
- Haigis 5 Meter Transceivers..... **\$14.95**
- Black crackle finish case, fitted with removable front panel, 10x9x7..... **79c**
- Philco all wave antenna kits complete **\$2.59**
- R.C.A. 211-511-50 watt tubes, brand new and in sealed cartons..... **\$9.95**

All prices above are net and do not include shipping charges. Please include necessary postage to cover this and parcel post insurance. Print name and address plainly. All C.O.D. orders over \$10 require a minimum deposit of 20%. No C.O.D. orders outside U. S.

We carry the famous R.M.E. 69, and are distributors for the following manufacturers and products:

- | | | |
|-----------------------------|-----------------------------|----------------------------|
| RCA. Raytheon. | Dubliler. R.M.E.. | Hall- |
| Sylvania. Cardwell. | crafters, Signal Mac | Keys |
| Hammarlund Mfg. Co. | Valpey, Universal, Weston. | Triplet. |
| U. T. C. Tobe | Anadyne, Amnerlite | Ohmite. Frost Fones. Trimm |
| Johnson. Astatic. Brush. | American Microphone, United | Sound. |
| Birnbach. Sangamo. Cornell- | | |

HARVEYS RADIO SHOP

103 West 43rd St. New York City

Now—a high powered

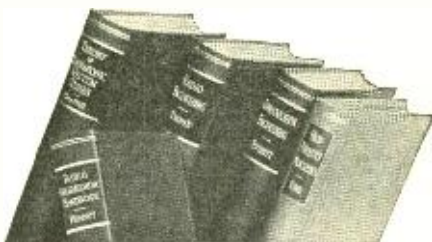

Radio Engineering Library

—especially selected by radio specialists of McGraw-Hill publications

—to give most complete, dependable coverage of facts needed by all whose fields are grounded on radio fundamentals

—available at a special price and terms.

These books cover circuit phenomena, tube theory, networks, measurements, and other subjects—give specialized treatment of all fields of practical design and application. They are books of recognized position in the literature—books you will refer to and be referred to often. If you are practical designer, researcher or engineer in any field based on radio, you want these books for the help they give in hundreds of problems throughout the whole field of radio engineering.

5 volumes, 2891 pages, 2000 illustrations

1. **Everitt's COMMUNICATION ENGINEERING**
2. **Terman's RADIO ENGINEERING**
3. **Chaffee's THEORY OF THERMIONIC VACUUM TUBES**
4. **Hund's HIGH-FREQUENCY MEASUREMENTS**
5. **Henney's RADIO ENGINEERING HANDBOOK**

10 days' examination. Special price. Monthly payments. \$26.00 worth of books cost you only \$23.50 under this offer. Add these standard works to your library now; pay small monthly installments, while you use the books.

SEND THIS ON-APPROVAL COUPON

McGraw-Hill Book Co., Inc
330 W. 42nd St., New York, N. Y.

Send me Radio Engineering Library, 5 vols., for 10 days' examination on approval. In 10 days I will send \$2.50, plus few cents postage, and \$3.00 monthly till \$23.50 is paid, or return books postpaid. (We pay postage on orders accompanied by remittance of first installment.)

Name

Address

City and State

Position

Company R W 4-36

Radio Aids in Flood

Portable and mobile radio systems, and other battery operated equipment, came in handy during the recent floods in the New England and Middle Atlantic sections. Even broadcasting stations that had to go off the air for lack of a.c. power scouted around for battery equipment so that an improvised service could be established. In this way, too, announcers at disrupted stations were able to broadcast first-hand descriptions of the extent and terror of the flood.

Stations throughout the country took the keenest interest in flood bulletins, and some sustaining programs were wiped out by the flood, as it were, to make time for the bulletins and eyewitness descriptions.

Amateurs as well as commercial radio lent a full and unstinting hand as wire telephone service was temporarily interrupted.

Set of 3 Special Shielded Coil for "Favorite" improved 5-tube a.c. broadcast circuit—\$1.85, postpaid.

Enclose stamped self-addressed envelope for free diagrams of T. R. F. and super-het. circuits (B.C.-S.W.)

RADIO DESIGN CO.

1353 Sterling Place

Brooklyn, New York

New "Raco" Outstanding Direct Reading ALL WAVE SIGNAL GENERATOR

MODEL 339

A. C. and D. C. OPERATED

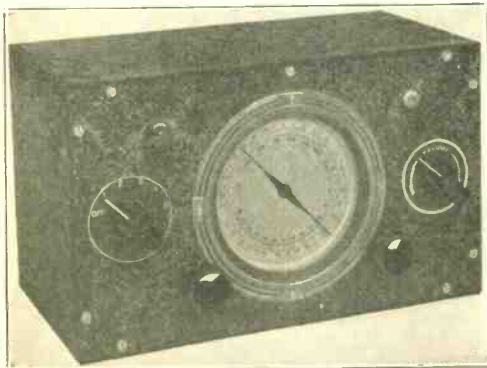

MODEL 339. A 5-band Signal Generator, 54 to 17,000 kc, all on fundamentals, switch operated, direct reading in frequency and wavelength; universal operation. Modulation on-off switch and attenuation. Electron coupled. Wired, tested, calibrated, with three tubes (6D6, 37 and neon). Shipping weight, 8 lbs. **\$16.00**

Selectivity vs. Tone

When the selectivity of a super is great enough to eliminate image interference as well as direct interference of carriers, it is so great that the upper side frequencies will be substantially reduced. The result will be excessive suppression of the higher audio frequencies. The output of the receiver will be predominantly bass, music will lack in brilliancy, voice will want in crispness, articulation will be poor, and, generally, the quality will be unsatisfactory.

If the selectivity in the radio frequency tuner is reduced much we encounter intolerable image interference. The only way, as many have found, of getting sufficient selectivity in this frequency level to eliminate image interference without cutting sidebands seriously is to use a high intermediate frequency. If the selectivity in the intermediate frequency level is reduced below a certain value, we meet direct interference between adjacent channels. And if we increase it so as to eliminate the interference, we cut the sidebands to the extent of making the quality of the output unsatisfactory.

There are two methods available by which necessary selectivity can be retained without ruining the quality. One is to employ a high selectivity and then build up the high audio frequency notes by an equalizer. The other is to employ band pass filters either in the radio frequency or the i.f. tuners or both.

THE highest requirements of precision and convenience for all-around work are met in the Model 339 Signal Generator that works on a.c. or d.c. of 90-125 volts, to measure frequencies from 54 to 17,000 kc and line up channels. It also serves for determining the frequency of a station that is being received. Model 339 is outstanding because of its attenuator and removable modulation. It is priced at only \$16.00 net.

The frequencies are in five bands, all on fundamentals:
(1)—5,400 to 17,000 kc. (2)—1,700 to 5,400 kc.
(3)—540 to 1,700 kc. (4)—170 to 540 kc.
(5)—54 to 170 kc.

It can be seen from the above that the calibration is in decimal reading, by noting left-hand column alone, then right-hand column alone. Two calibrations afford maximum spreadout, each at outside of dial scale. The two inside scales are for reading wavelengths, 18 to 5,500 meters.

Coincidence of generated frequency and scale reading is 1 per cent. This high order of accuracy obtains in no other instrument selling at less than twice the cost of the 339.

Many, no doubt, have been somewhat confused by the numerous types of signal generators, but will note that the best of them cover wide ranges on fundamentals, have an attenuator, and permit of presence or absence of modulation. Also they have a vernier dial and are direct-reading in frequencies, accurate to at least 3 per cent. The 339 has all these advantages, besides affording wavelength determinations as well, and operation on 90-125 volts a.c. (any commercial frequency) or d.c. And the accuracy is three times as great. Moreover, the 339 is well built, for lifetime use, and covers all waves fundamentally, besides permitting measurements of frequencies up to 100 mc (down to 3 meters) by resort to a slight calculation method, applying a simplified harmonic system to the 5,400 to 17,000 kc fundamental band.

The 339 has a 6D6 r.f. oscillator, a 37 rectifier tube, so that d.c. is used on the plate, while modulation is provided by neon tube relaxation oscillator at a frequency of about 1,000 cycles.

Model 339, wired, calibrated, adjusted, complete with three tubes, ready to operate; instructions (shipping weight, 8 lbs.) **\$16.00**

Model 339K, complete kit, instructions, less only tubes, **\$12.50**

Radio Constructors Laboratories

136 Liberty Street, Dept. W-211, N. Y. City

CLASSIFIED ADVERTISEMENTS

7 cents a word. \$1.00 minimum.

RADIO AND TELEGRAPHY

AMATEUR LICENSES—Complete training. Resident and correspondent courses. Every graduate a licensed operator. \$1.50 weekly. Booklet. New York wireless School, 1123 Broadway, New York.

POCKET RADIO—\$3.85 complete. Illustrated Bargain Catalogue. 10c. American Business Service, 353 RWM, Shamokin, Penna.

HUNDREDS of new and rare items, replacement parts and supplies. Send 3c for new, 60-page, wholesale catalog. Auto-power, 408 S. Hoyne Avenue, Chicago.

SLOW speed wind charger from automobile generator. Complete plans 10c. with 20 other generator changes. LeJay Manufacturing, 3439 Hennepin, Minneapolis, Minn.

GOVERNMENT gives free Radio Operator' training for service on aircraft, ships. Salary, expenses paid. Information booklet. how to qualify, apply 20c. Continental, Box 344, Indianapolis, Ind.

RADIO engineering, broadcasting, aviation and police radio, servicing, marine and Morse telegraphy taught thoroughly. All expenses low. Catalog free. Dodge's Institute, Ames St., Valparaiso, Ind.

RADIOS wholesale! Latest models—all voltages. Catalog. Bart, Knoxville, Tennessee.

ELECTRICAL SUPPLIES—EQUIPMENT

HIGH GAIN IRON CORE I. F. Transformers 175 or 456 k.c. 85c each. United Coil Co., 2220 South Kedzie, Chicago, Ills.

WAGNER MOTOR AND GENERATOR SET especially built for broadcasting purpose. 2,200 volt. 1½ amp. Price \$145.00. I. C. Patsch & Son, Houston, Penna.

MISCELLANEOUS

24 WAYS OF MAKING MONEY. Big list of valuable coin producing secrets for only 10c. Benson Service, Hillside, N. J.

BOYS OF SCHOOL AGE can earn money selling our products during spare time. No experience or capital required. Write LAMB MAILING CO., Meriden, Conn.

UP TO \$5,000 paid for old books. Pictures up to \$200,000. Also old Newspapers, Letters, etc. Syllabus dime. Dept. 130, Buden-Kaye Enterprises, Plymouth, Penna.

BURNING PERFUME CANDLES. Real money-maker, 300% profit. Send 25c for sample and agents' prices. Gold Ray Perfume Co., 116 Penn Avenue, West Reading, Pa.

100 BLADES—Finest grade, genuine Mayfair double edge, blue steel. Postpaid for \$1.00 bill or M. O. Matthews Sales, Midland, Pa.

"MODERN WOOD SCULPTURE." Complete instruction book on carving statues, only \$1.00. Lee Wood Art Studio, Centerville, Iowa.

MIDGET BIBLE, no larger than a postage stamp. 25c postpaid. Lee's, 1265 Brocklev, Cleveland, Ohio.

MOTION PICTURES AND SOUND EQUIPMENT

MOVIE Projector \$5.00. Film 2c foot. Block, 1451 Broadway, New York.

LEARN motion picture theatre business. Home-study training; management, advertising, projection. Ninth year. Catalogs. Theatre Institute, Elmira, New York.

PLANS, BLUEPRINTS. INSTRUCTIONS

REVERSE fractional horsepower motors with throw switch. Blueprint with instructions 25c coin. 271 - 21 Street, Barber-ton, Ohio.

MAKE blueprints. Instructions \$1. Particulars stamp. Earl Dorris, Moorcroft, Wyo.

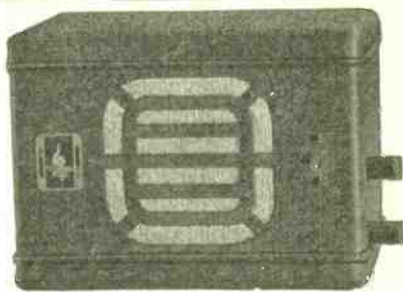

EMERSON 6 Tube Auto Set

full superheterodyne. Powerful, selective. Interference from engine noises is eliminated with built-in filters. Spark plug suppressors are unnecessary. This compact single unit employs a 3 gang condenser, efficient I. F. transformers, diode detector, 5 inch full dynamic speaker, automatic volume control and tone control. Remote control unit included, has aeroplane dial with key and pilot light. Chassis fortified against road shocks, dust, heat and cold. Tubes used are RCA 2-78, 16A7, 2-85, 1-41. Size 6¾" high, 9½" wide, 6¾" wide. Shpg. wt. 21 lbs. Mounts with only 3 bolts. Complete with RCA tubes, instructions and guarantee **\$21.50**

THOR RADIO

167 GREENWICH ST., near Cortlandt St.
NEW YORK CITY

PICTURE DIAGRAMS

(Regular Blueprint Style, with Parts Shown in Their Real Positions)

10 to 1,500 METERS, TWO TUBES

6J7 regenerative detector, 6C5 rectifier, for ear-phone reception, universal use (a.c. or d.c., 90-130 line volts). Plug-in coils and .00014 mfd. tuning condenser. Printed in February, 1936, issue. Send 25c for a copy.

2½ to 555 METERS, FIVE TUBES

MG-6K7 r.f., MG-6K7 regenerative detector, MG-43 output tube and MG-25Z5 rectifier, using all metal or metal-glass tubes, as preferred. Also a 76 or 37 for 2½ to 15 meters, with super-regeneration. Switch coils for 15-555 meters, plug-ins for 2½ to 15 meters. Full data, Universal 90-130 line volts a.c. or d.c. Printed in March, 1936, issue with two-page blueprint. Send 25c for a copy.

RADIO WORLD

145 West 45th Street, New York City

A COMBINATION OFFER! RADIO WORLD and "RADIO NEWS" \$3.50

Canadian and Foreign, \$1.50 extra on this offer.

You can obtain the two leading radio technical magazines that cater to experimenters, service men and students, for one year each, at a saving of \$1.50. The regular mall subscription rate for RADIO WORLD for one year is \$2.50. Send in \$1.00 extra, get "Radio News" also for a year—a new issue each month for twelve months. Total 24 issues for \$3.50.

RADIO WORLD, 145 West 45th Street, N. Y. City

**THOR'S LATEST P.A. 5
16 WATT HI FIDELITY
A QUALITY AMPLIFIER
WITH A REAL WALLOP!**



PURE CLASS A—16 WATTS

Continuous output. 20 watt peak. Rated gain over 75dB. Less than 2dB variation between 20 to 14,000 cycles. This sensational performer is built around the following tubes: 1-56, 1-57, 1-83V, 2-2 Bbs in Push Pull.

Speaker excitation from Amplifier as Field is employed as choke. Speaker field should be between 750-1250 ohms

Heater Type Rectifier delivers voltages only when tubes are fully warmed. Volume control, illuminated panel light and continuous type tone control on front rack. Speaker plug and double input with selector switch mounted on rear rack. Overall size of amplifier 12 1/2" long, 8" deep and 8" high. Chassis and ventilated cover of black oven-baked scratchless crackle.

All parts heavy duty with rated safety factor makes this a real P.A. job for dependable and sensational performance. A valve that can't be beat. Hi-impedance pickup or tuner can be fed directly to input. See other Thor ads in this issue for further details.

P.A. 5 completely wired and tested **\$14.95**

Set of 3 RCA tubes
2 trial tubes..... **\$3.95**

Rola K-12 Speaker, with output
transformer to match..... **\$3.95**

Rola G-12 Speaker Hi-Fidelity with
output transformer to match..... **\$9.95**

Complete instructions with every outfit.

ORDER DIRECT—DEPT R.W.-4

THOR RADIO
167 GREENWICH STREET N. Y. CITY

SCRAMBLED SPEECH

- At last, the long awaited hook-up of a speech inverter.
- Who hasn't heard scrambled speech on the short waves!
- Build this device that will un-scramble speech as well as scramble it. Hooks to the audio output of your receiver.
- Can be built from the usual junk-box parts—takes up small space—as simple to operate as an audio amplifier.
- Will scramble your own voice or music when hooked to a microphone.
- Circuit diagram with instructions 25 cents—no stamps.

WIRELESS SPECIALTY CO.
55 Oak Lane Trenton, New Jersey

METAL CHASSIS

We can supply chassis for any make receiver, experimental or otherwise. Inquiries should be accompanied with sketch and complete details enabling us to give quick service as to prices and delivery.

KORROL MFG. CO., Inc.
Dept. R.W. 436
232 Greenwich St. New York City

**SPECIAL 2-FOR-1 OFFER
RADIO WORLD**

Radio World is \$2.50 a year (12 issues), 25c per copy. Canada and foreign, \$3.00 yearly. Offers of Radio World and other worthwhile publications for one full year on each, (NET):

- RADIO WORLD and SHORT-WAVE CRAFT, \$3.50.
- RADIO WORLD and POPULAR SCIENCE MONTHLY, \$3.50.
- RADIO WORLD and RADIO-CRAFT (12 issues), \$3.50.
- RADIO WORLD and RADIO INDEX (monthly, 10 issues) stations, programs, etc., \$3.50.
- RADIO WORLD and EVERYDAY SCIENCE and MECHANICS (monthly), \$3.50.
- RADIO WORLD and SERVICE (monthly), \$3.50.
- RADIO WORLD and TRUE STORY (monthly), \$3.00.
- RADIO WORLD and BOYS' LIFE (monthly), \$3.50.
- RADIO WORLD and LIBERTY (weekly), \$3.00 U. S. only.

Select any one of these magazines and get for an entire year by sending in a year's subscription for RADIO WORLD at the regular price, \$2.50, plus a small additional amount, per quotations above. (Add \$1.50 for extra foreign or Canadian postage for both publications.)

Name

Address

City and State.....

**When writing to advertisers, please mention
Radio World.**

ONE PICTURE!
IS
WORTH 20,000 WORDS
Real Values in P. A. Equipment

BABY GRAND

3-TUBE POWER AMPLIFIER using 57-2A5-80 to deliver full 4 watts output. Manual volume and tone controls mounted on control board. An ideal P.A. rig for home record reproduction and communication work. Completely self-powered. Oversize parts. Complete in black crackle case, built-in Rola 6" Speaker and 3 RCA tubes for AC 10.95
Size 10x6x7. Shipping weight 18 lbs. Universal 11.95
AC-DC. 2525-6C6-43 complete



MIGHTY MITE AMPLIFIER

FULL 4-WATT OUTPUT from 57-2A5-80. Volume and tone control on rack. A rugged compact with oversize parts that fills a multitude of purpose. 2500 ohm. Speaker used as choke. Size 9x7x6. Shipping weight 12 lbs. Completely wired 5.95
Set of 3 RCA tubes 1-57, 1-2A5, 1-8C 1.21
8" Dynamic Speaker with Output Transformer to match 2.29



WALCO PICKUP

HI IMPEDANCE, well balanced pickup with built-in volume control. Connects direct to grid or input as an above pictured amplifiers. Good frequency response. Shipping weight 5 lbs. 3.79

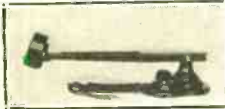

AUDAK PICKUP

MODEL 100—HI Impedance unit. Needs no transformer, connects direct to grid and ground. Extremely light in weight and only 8 1/2" long. Shipping weight 3.65



REAL QUALITY TONE. Shipping weight 5 lbs.

INPUT MIXER BOX

Black crystalline finish metal case containing mike transformer, battery and volume control plus filter. Mike and pickup connection permanently, and built in selector switch throws either into circuit. Used on all amplifiers for mike inputs. Size 8x5x3 1/2. Shipping weight 8 lbs. Complete with cord and battery 3.49



GENUINE

Astatic Crystal
Hi Fidelity crystal pickup at great savings. The finest in record reproduction agents. Light in weight and well balanced. Feeds direct to input. Complete with data sheet. Order now 6.19



Nothing Finer—Limited Quantities

ORDER DIRECT—DEPT. RW4

THOR RADIO
167 GREENWICH STREET N. Y. CITY

NEW! H. G. CISIN'S **Metal Tube AIR SCOUT**
ALL ELECTRIC

Only Set of Its Kind in the World
Pat. Pending U. S. Serial No. 592,586. Operates on A.C. or D.C. Self-Contained Power Supply.

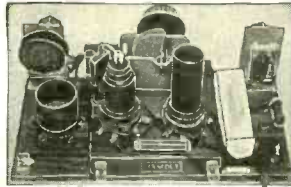

Rear view showing New Metal Tubes

GREATER SENSITIVITY. Four plug-in coils cover 10 to 200 meters. Extra coils for Broadcast Receiver, also Special long wave unit. Operates several headsets simultaneously. Speaker on strong stations.
Complete, Assembled Kit, with instructions and picture diagram, and all four short wave coils, ready to wire \$3.95
Set of Matched Metal Tubes \$2.50
Special Long Wave Unit w. Coil. 550 to 1500 meters .95
Broadcast Coils (Two) 1.45

Earphone (single)..... 50
Total\$9.35
SPECIAL COMBINATION OFFER—Assembled Kit, metal tubes, 6 coils, including Long Wave Unit, earphone \$8.40
Above: Custom-Built, wired and laboratory tested, ready to use, \$1.00 extra.

10c to cover printing, etc. brings copy of new booklet, "SHORT WAVE TRAVEL TIPS," including valuable world short wave log and all-wave data! Order at Once!
H. G. CISIN Chief Engineer
Allied Engineering Institute
98 Park Place, Dept. 3-C, New York, N. Y.

You need **2** books
.. these **2** books
MATHEMATICS
of Radio Servicing

Introduces and explains the use of arithmetic and elementary algebra in connection with units, color code, meter scales, Ohm's Law, alternating currents, ohmmeter testing, wattage rating, series and parallel connections, capacity, inductance, mixed circuits, vacuum tubes, curves, the decibel, etc, etc, and has numerous examples.
Plainly written and easy to understand. Only useful data included. M. N. Beitman, author. Size, 8 1/2 x 11 in.

PRINCIPLES of PUBLIC ADDRESS SYSTEMS

A practical handbook, full of useful information, fully illustrated, written by M. N. Beitman, an engineer and noted authority on audio amplifiers.
Considers in detail various microphones, radio and phonograph inputs, acoustic feedback, mixing and volume controls, use of vacuum tubes, interstage coupling, power amplifiers, output coupling, loud speaker placement, the decibel, P.A. measurements, power level, and other points of importance, including actual circuit diagrams of tested P.A. systems.
Price, 50c each book.

SUPREME PUBLICATIONS
3727 West 13th St. Chicago, Illinois

ANNIVERSARY SPECIALS ON ALL FAMOUS THOR KITS

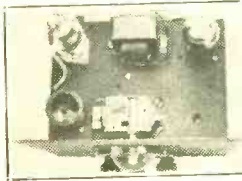

THOR'S FAMOUS JR. 2

All Wave Receiver using 6F7 Triode Pentode 37. Covers all bands from 11-600 meters with new type plug in coils. Parts mounted on black crackle chassis and panel. An all electric outfit, works on either AC or DC and provides good head-phone volume.

over entire spectrum. Priced complete with all parts, coils, tubes and double head phones... **6.75**
Full instructions and all wire and solder included. Ready to wire. Shipping weight 18 lbs. Size 9x7x8. Cabinet to match... **.49c**

THOR'S FAMOUS 2X CONVERTER

A simple short wave converter used in conjunction with any standard broadcast receiver. Covers bands from 19-45 and 65 to 200 meters. Completely self-powered, supplies its own voltage from built-in power pack. Only 2 wires to connect, aerial and ground. Uses 6A7 and 80. COMPLETELY WIRED, READY TO OPERATE with all coils mounted in a band switch to select wave lengths. Tubes and black crackle cabinet included. Illuminated aeroplane dial. Shipping weight 20 lbs. Size 9x7x8... **9.75**

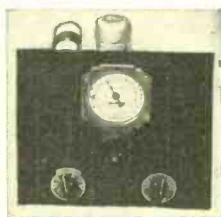

THOR'S FAMOUS AC-5

A highly efficient receiver of exceptional merit for the broadcast band. Employs Hi-gain coils in triple tuned circuit, built around the following tubes 2-6D6, 1-6C6, 1-42, 1-80. Heavy duty parts throughout, chassis mounted. Size 12 1/2 x 8x8. Full instructions, diagrams, all parts, 8" dynamic speaker. O. P. trans. **10.75**
to match
Set of 5 genuine RCA tubes **2.48**



THOR'S HI-FIDELITY TUNER

A 5 tube TRF tuner designed solely for quality reception in conjunction with P.A. outfits. Covers the broadcast band with a circuit using Litz wound coils and 4 gang condensers with the following tubes: 3-6D6, 1-76, 1-80. available in 2 1/2 volt models. Completely mounted on chassis. 10 3/4 x 12 1/2 x 8 with aeroplane dial and built in plug for P.A. outfit so switch turns both at one operation. Sensitivity and tune controls incorporated in tuner. Supplies all its own voltages from builtin power pack. Complete kit of parts including **11.50**
all diagrams and instructions. Ready to wire.
Set of 5 RCA tubes. Shipping weight **2.29**
20 lbs.

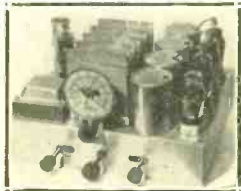

ORDER DIRECT, DEPT. RW-4
THOR RADIO
167 GREENWICH STREET N. Y. CITY

TRANSFORMERS

FOR ALL PURPOSES

for example:

TRANSCEIVER TRANSFORMERS

F-532-B—Microphone and Plate Primaries to Grid Secondary. Uncased, light weight, Net... **\$.92**

F-533-B—Transceiver Output from plate of 33, 38, 41, etc. to 130,1000 or 2000 ohm handset or phones... **\$.100**

F-536-B—Similar to F-532-B but for more powerful Transceiver using a 19 as push-pull R.F., 30 as audio driver, and 19 as Class B Modulator... **\$.105**

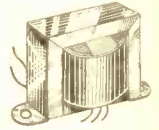

F-534C—Class B Input, 30 driver to 19 Grids Class B... **\$.80**

F-535-B—Class B Output from 19 Twin to modulate 19. Sec. handles plate current of r.f. stage, impedance approx. 2700 ohms, or any 7 watt stage approx 50 m.a. at 135 volts... **\$.117**

General Replacement Transformers

will be found in our
CATALOGUE No. 51-C

Three examples out of 161:

No. 210—300-0-300 V. 40 m.a.; 2.5 V. 5.5 A; 5V. 2A... **\$.111**

No. 209—330-0-330 V. 60 m.a.; 2.5 V. 8.75 A; 5V. 3A... **\$.180**

No. 1103—Single Plate to Push-pull Grids... **\$.98**



High Fidelity Audio Transformers for Public Address, Broadcast and Amateur Stations will be found in our catalogues No. 70, No. 70-A. Description of all types for microphones, matching, interstage, and output, all fully cased and shielded. Useful diagrams included.

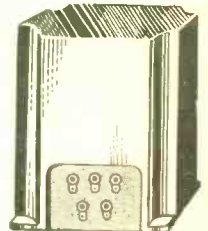

AMATEURS!

SEND FOR CATALOGUE
No. 52-C

Contains nearly a hundred stock transformers and chokes for all power phone and C.W. rigs, designed by Boyd Phelps. W2BP-W9BP. Illustration shows FTP-56 which delivers 1/4 K.W. and costs \$9.50 net.

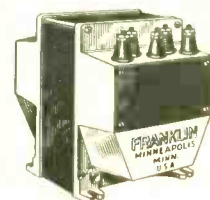

Any of the above catalogues free for the asking. If in a hurry, order direct from this ad or see your local jobber. If he does not have these lines tell him he is missing something well worth while.

FRANKLIN TRANSFORMER MANUFACTURING COMPANY

607-609 22nd Ave. N.E., Minneapolis, Minn.

ANNIVERSARY SPECIALS

ON NEW PARTS and EQUIPMENT

SPEAKER

Field Supply

Delivers 100 volts at 100 mil for speaker excitation: for 1 1250 ohm speaker, or 2 2500 ohm speakers. Quiet humfree operation. Complete with cord and RCA tube. Shipping weight 4 lbs. for AC. Black crackle case. **2.49**



LINE

Noise Filter

Efficient filtering device to eliminate noise reaching the receiver thru the power line. For AC or DC operation. Connects between set and line with extreme ground connection. Complete with cord and plug. Shipping weight 8 lbs. **1.69**



Jewel
0-3 volt
AC
0-2 volt
AC
1.49
ea.



Weston
0-3 volt
0-2 volt
AC
1.49
ea.

UNIVERSAL Meter Cases

Oven baked scratchless case. With all mounting holes drilled. Limited quantities.

For all 2" meters...49c
For all 3" meters...59c
For all 3 1/4" meters...59c

Shpg wt., 3 lbs.

FULLY
GUARANTEED
Securely

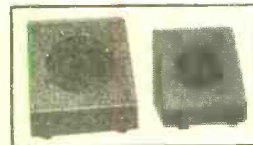

LIMITED
QUANTITIES
Shipping weight

SURPLUS
STOCK
3lbs. Packed

PORTABLE

Battery Receiver

6 tube powerful super-heterodyne employing new sensitive low drain 2 volt tubes. 3-1B4, 1-30, 1-52, 1-950 3 gang condenser, RCA inductor speaker all self contained with batteries included. Battery unit delivers 135 volts B, 3 volts of A and 4 1/2 volts C. Leatherette case as pictured measures 11" wide, 17" high and 7" deep. Tuning range 1700 to 540 kc. dial calibrated in kilocycles. This is an ideal set for all portable uses, highly sensitive, rugged and economical. Complete with 6 tubes, batteries ready to operate. Fully guaranteed. Shpg. wt. **19.95**
25 lbs.

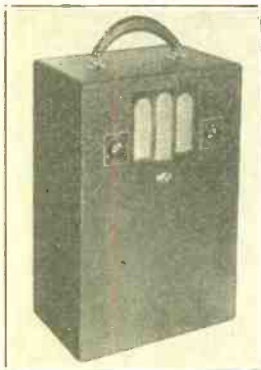

ORDER DIRECT

24
HOUR
SERVICE

THOR RADIO

MAIL
ORDERS
FILLED

167 GREENWICH STREET N. Y. CITY

EXCLUSIVELY FOR HAMS!

A Ham Catalog That Beats Them All!

This is the world's greatest exclusive ham catalog because:

1. It has more pages and lists more items than any other.
2. More nationally known manufacturers are represented. . . . Here are but a few: National, Hammarlund, Lafayette, R.C.A., Tobe, Cardwell, Trutest, Bliley, Raytheon, U.T.C., Thor-darson, etc.
3. It has been compiled BY Amateurs FOR Amateurs (we have over 50 amateurs on our staff).
4. It contains practical ham data: diagrams, coil winding data, questions and answers on ham receiving and x'mitting, etc.
5. It is the first catalog to describe the new R.C.A. ACR-175 Receiver and the new U.T.C. and Thordarson Transmitters!



It's
FREE!

But the supply is limited, so you'll have to hurry. Simply attach the coupon to your QSL Card and mail today!

"It takes SIZE to make Rapid Service possible."

WHOLESALE RADIO SERVICE CO.

NEW YORK, N.Y.
100 SIXTH AVE.

CHICAGO, ILL. ATLANTA, GA.
901 W. JACKSON BLVD. 490 W. PEACHTREE ST. NW
BRONX, N.Y. NEWARK, N.J.
542 E. FORDHAM RD. 219 CENTRAL AVE.

Dept. RX-46 . . . Gentlemen:

Please rush me a free copy of your exclusive ham catalog No. 60.

Name

Address

City..... State.....

THE NEW NOISE SILENCER

The Lamb noise "Check Valve" has been acclaimed as one of the greatest discoveries in Radio! For the first time, really noise free reception is possible. Harrison presents a compact version of this amazing development as described in QST and Radio World. A neat metal case measuring only 2" x 3 1/4" x 4 1/4" houses all necessary parts and tubes. Just bolt the "Noise Silencer" to your receiver and make three simple clip connections. A few minor adjustments and you enjoy real reception on all bands, unmarred by sparking motors, automobile ignition, dial telephones, oil burners, etc. Draws only a few mills plate current from the receiver.

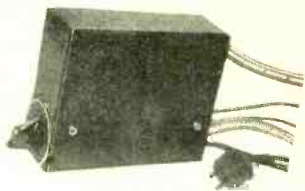

COMPLETE KIT of all necessary, high grade parts, crystal finished cabinet with all holes drilled, and complete instructions **\$3.85**

Three Sylvania metal tubes \$2.50
WIRED AND TESTED—Ready to operate, with tubes—\$8.55 for Superheterodyne Receivers only. (BCL and Amateur.) Mention make and model of set when ordering.

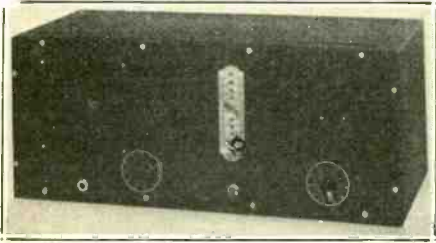

ROYAL "PR-SIX" COMMUNICATIONS RECEIVER

★ 6K7 — 6K7 — 6C5 — 6C5 — 6F6 — 5Z4 ★
9 1/4" to 625 Meters • Continuous Bandspread
FREE FIVE DAY TRIAL



COMPLETE "PR-SIX"

receiver with built-in power supply and large dynamic speaker. Complete with SIX real STEEL Tubes, all coils 9 1/4" to 625 meters, and attractively finished heavy steel cabinet, Laboratory wired and tested, ready to plug in and operate! **\$31.45**

**Order Yours Today!
Prompt Delivery
Guaranteed!**



IT'S YOURS! FREE NEW HARRISON RECEIVER CATALOG

The Short Wave Receiver catalog that will mean real money in your pocket when you buy your next set! Short Wave Fan, or Amateur—your receiver is here.

All the well known makes—from the new Hammarlund "Super-Pro" down to the \$3.45 Harrison "Multi-Kit"—are illustrated and fully described in this NEW Harrison Catalog.

Send for your copy today! It's valuable!—But to you—a prospective set purchaser—we send it

ABSOLUTELY FREE ! !

Gentlemen: RW-4
Kindly send me without cost or obligation your new Short Wave Receiver Catalog. I am particularly interested in the receiver.
NAME
(Please Print)
ADDRESS
CITY & STATE

HARRISON RADIO COMPANY

12 West Broadway

Dept. RW-4

New York, N. Y.

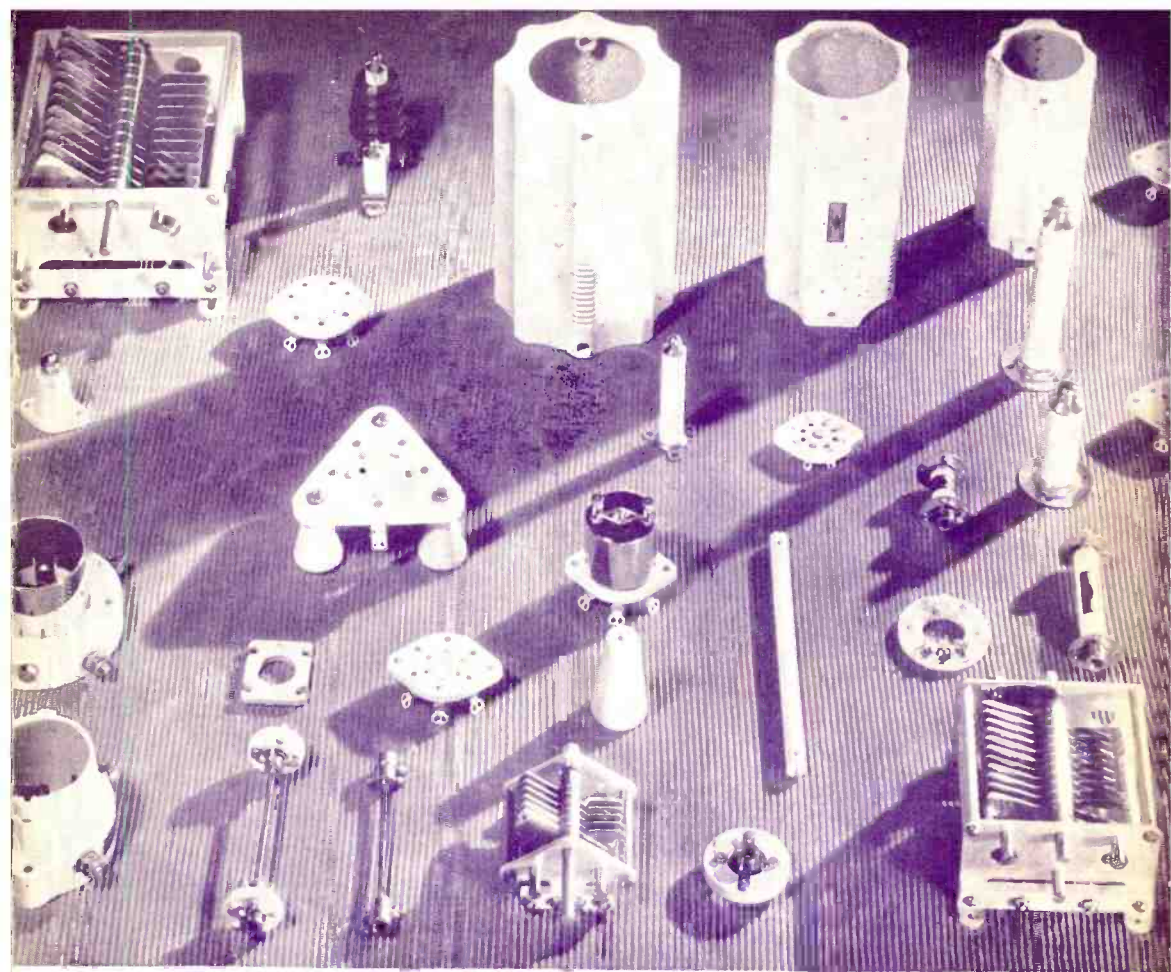

● National offers a thoroughly engineered part for nearly every radio purpose. The entire line cannot be compressed into our twenty-page catalogue, much less a single page. But look over the group above. Transmitting condensers from the little 1000 volt TMS in the foreground to the 12,000 volt TMA at the rear. Low loss ceramic coil forms for every amateur band. Low loss sockets for nearly every tube type, from acorns to power pentodes. Flexible couplings from the little TX-12, which will work around a corner, to the big fellows for heavy condensers, high voltages, and low-losses. Strain insulators, spreaders, lead-ins for the antenna; stand-offs, chokes, dials for the rig. National has what it takes.

NATIONAL



COMPANY

Only
\$1800
 for this **TUBE TESTER**



MODEL
 430

- ★ Tests all type tubes — Metal, Glass, Glass-Metal.
- ★ Line voltage adjustment.
- ★ Leakage and Short Test.
- ★ Triplet Direct Reading Instrument (GOOD-BAD Scale)

An up-to-the-minute 1936 Tube Tester. Five flush mounted sockets provide for all type tubes. The tester operation is very simple and indicates condition of tube for dealer and customer on Direct Reading GOOD-BAD Triplet colored meter scale. The Tester is designed to indicate all inner element shorts and make leakage tests.

Complete in attractive, sturdy quartered-oak case.

Attractive sloping panel of silver and black. Suitable for portable and counter use. Model 430—Dealer Net Price, **\$18.00**

Model 431—Same as 430 except has Readrite GOOD-BAD meter.

Dealer Net Price \$14.40

MAIL THIS COUPON

READRITE METER WORKS,
 427 College St., Bluffton, Ohio

Without obligation please send me more information on Model 430 Model 431
 Send complete catalogue.

Name

Address

City State

Readrite

TESTERS AND METERS